



# METAL ALLIANCE

A Value Added Supplier of Metals

**50AIV**

**5V Crimp Panel**



**INSTALLATION  
GUIDE**



The application and detail drawings depicted herein are strictly for illustration purposes only and may not be applicable to all environmental conditions, building code requirements, building designs or changes. It is the responsibility of the building owner, contractor, installer and design professional to determine and verify the suitability of this product(s) for the job, as well as applicable regulations, building codes, and accepted industry practices for installation. Consult with all authorities having jurisdiction and adapt recommendations enclosed herein to meet those requirements. When local or controlling codes, or insurance requirements conflict with these recommendations, the metal panel supplier should be consulted.

All instructions in this guide assume that a qualified firm or individual has been contracted to install the product(s) described herein. Failure to comply with these recommendations may limit or void any applicable warranties provided by your supplier. Always consult your specific product warranties to understand your responsibilities and contact your panel supplier if you have questions.

The details shown herein are proven methods of construction. However, a weathertight roof is the responsibility of the installer. **Metal Alliance LLC shall be held harmless from any and all claims resulting from a lack of watertightness as a result of following these suggested typical detail drawings.** Descriptions of products and specifications contained herein were in effect at the time this publication was approved for printing and subject to change at any time. **Metal Alliance reserves the right to make, and shall be held harmless from claims resulting from changes to product design and/or specifications, or the discontinuation of products at any time. To ensure you have the latest information available, contact your metal panel supplier.**

For complete performance specifications, product limitations, and disclaimers, please consult the metal and finish warranties for your specific product(s). For a description of warranties that may be available, contact a Metal Alliance representative.

2120 SW Poma Dr - Palm City, FL 34990

2500-B Broening Hwy - Baltimore, MD 21224

☎ 844.638.2548 ✉ [needmetal@metalalliance.com](mailto:needmetal@metalalliance.com)

**metalalliance.com**



### Panel Description

- 4 Specifications
- 4 Testing

### Product Safety and Handling

- 5 Safety
- 5 Delivery and Receiving
- 5 Storage
- 6 Handling

### Pre-Installation

- 8 Important Information for Architect/Contractor/Installer
- 8 Ordering and Measuring
- 8 Roof Deck Preparation
- 9 Before Panel Installation
- 9 Field Cutting, Dissimilar Metals and Oil Canning
- 9 Fastener, Sealant and Accessory Information
- 11 Pre-Installation Checklist

### Cleaning, Maintenance and Repairs

- 14 Routine Maintenance
- 15 Cleaning Metal Panels
- 17 Repairs

### Installing Metal Panels

- 18 Order of Installation
- 18 Panel Installation
- 19 Fastener Installation
- 21 Fastener Patterns
- 22 Field Cutting

### Installation Details

- 24 Fixed Ridge/Hip
- 25 Notched Ridge Detail
- 26 Vented Ridges
- 29 Valleys
- 30 Eaves
- 32 Rake/Gable
- 33 Peak
- 34 Headwalls
- 37 Valley Walls
- 40 Sidewalls
- 43 Slope Transition
- 44 Penetration
- 45 Endlap

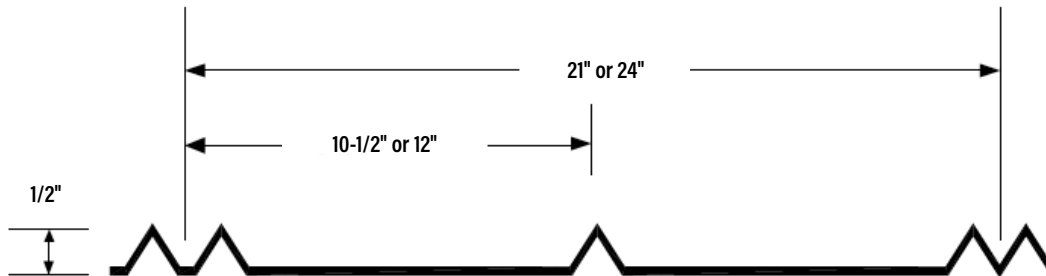
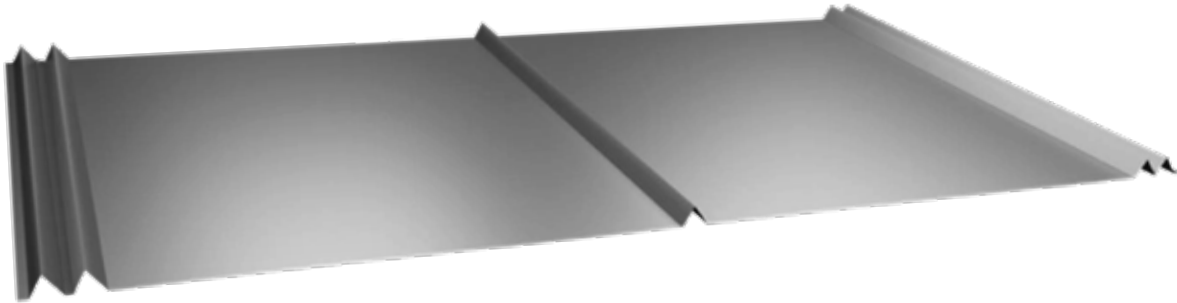

All dimensions are nominal.

## PANEL SPECIFICATIONS

- **Description:** 1/2" Double "V" profile
- **Material:** 24-, 26-gauge steel, .032, .040 aluminum
- **Slope:** 3:12 or greater, contact supplier for site-specific availability
- **Support:** 15/32" or greater thickness wood deck or plywood
- **Coverage:** 21 inches or 24 inches
- **Spacing:** 10-1/2 or 12-inches on center
- **Finish:** Acrylic-Coated Galvalume®, Tedlar® PVF Film, 70% Kynar 500® PVDF, SMP
- **Options:** Striated or pencil bead seam; contact supplier for availability

## PANEL TESTING

- **Uplift Resistance:** UL580, UL 1897, TAS 125
- **Wind-Driven Rain:** TAS 100
- **Tensile Strength:** ASTM E8
- **Fire Rating:** UL 790
- **Florida Building Code:** Approved HVHZ (29.5")/ Non-HVHZ (29.5" and 21")
- **Miami-Dade Approved:** Product Control Approved



## Safety

It is the installer's responsibility to study and ensure compliance with all applicable OSHA and other safety requirements before starting any project, including but not limited to, record keeping, fall protection, ladder safety, electrical and hand tools, and personal protective garments and equipment. It is recommended when working with metal panels to wear heavy gloves and long sleeves to avoid cuts from sharp edges. When power cutting or drilling metal panels, always wear safety glasses to prevent eye injury from flying debris. Use extreme caution when walking on a metal roof. Metal panels may become slippery, so always wear shoes with non-slip soles and avoid working on metal roofs during wet conditions. Do not walk on a metal roof which does not have a solid deck beneath it and avoid walking on seams. Safety railing, netting, harnesses, and safety lines should be provided and used by all crewmembers working on the roof.

## Material Receiving and Delivery

Whether your metal panels will be roll-formed at the jobsite or prefabricated, bundled and delivered will depend on the terms of your order and agreement with your supplier. It is generally the contractor's responsibility to unload delivered material and inspect for shortages or damages at time of delivery. Similarly, contractors that pick up their orders in lieu of delivery accept responsibility for verifying and securing material for transport before leaving. It is recommended that contractors have sufficient personnel present at time of delivery to facilitate receiving, inspecting, reporting shortages and/or damages, staging and storing of the roofing panels, trim and other delivered products. Notify your supplier of shortages, damages or discrepancies in accordance with the terms of your order. For additional information about material and delivery of metal panels, consult with your metal panel supplier.

## Storage

It is the contractor's responsibility to store panels properly. Materials should be installed soon after delivery, preferably beginning the following day. It is recommended that all material be stored in a dry area protected from the elements on the jobsite. If material must be stored outside, proper precautions must be taken to protect the material from damage and trapping moisture beneath, on top of, and between panels to avoid water stains or white rust. Panels must be stored at an angle to promote drainage of water off the bundle. Sufficient support must be provided to the raised and angled bundles to avoid excessive bowing, which may result in puddling of water. Bundles must be completely sheltered with a loose-fitting waterproof tarp to protect them during rain, while also allowing for air circulation and drying of condensed water. Plastic is not recommended since it may cause sweating and condensation.



In addition to water there are other important factors that contribute to the corrosion of stored panels including temperature and exposure time. Given enough time, panels will eventually become wet and storage corrosion may occur under most job site conditions. Even in a well-protected bundle the natural temperature and humidity variations will cause water to condense on and between panels. Shipping the bundle from a cold area to a warm area will cause water to condense not only on the bundle but also between the panels.

## Handling of Metal Panels

• **General Handling:** Each bundle should be handled with care to avoid product damage. Proper care should be used to prevent bending panels or scratching the finish. Clean protective gloves should be worn when handling metal panels to protect the finish and avoid injury from cuts. To prevent panel damage, follow these steps for unloading and handling bundle:

- 1 Bundle should remain banded and intact during any handling** and remain banded until the panels are ready to be installed.
- 2 Never lift bundle by its banding.** Do not lift with ropes or wires. Always lift bundle as close as possible to its center of gravity.
- 3 Never lift a panel by its ends.** Carry a panel by its longitudinal edge and in a vertical (not flat) position. For panels over 10 ft., two or more people should lift and carry the panel from the same edge. (See Illustration 1.)

ILLUSTRATION 1

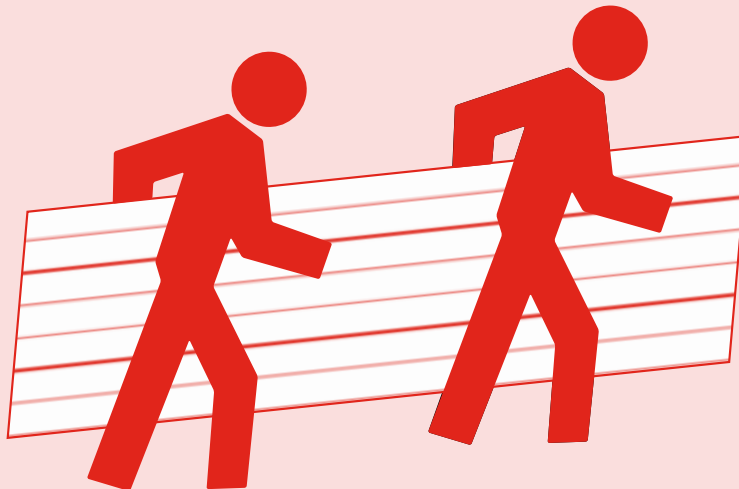

- 4 Once a bundle is opened, individual panels must be handled with care to prevent panel buckling or finish damage.** Never slide a panel over another panel when removing it from the bundle. A panel should be lifted up from the bundle in order to minimize the possibility of damaging the finish.



- **Mechanical Handling:** When lifting by crane, use a spreader bar of appropriate length with nylon band slings. (See Illustration 2.) Do not use cable slings as they may damage panels. A panel bundle of manageable length may be lifted by forklift. Set forklift forks to their maximum spacing apart and center the load on the forks to prevent panel damage.

ILLUSTRATION 2

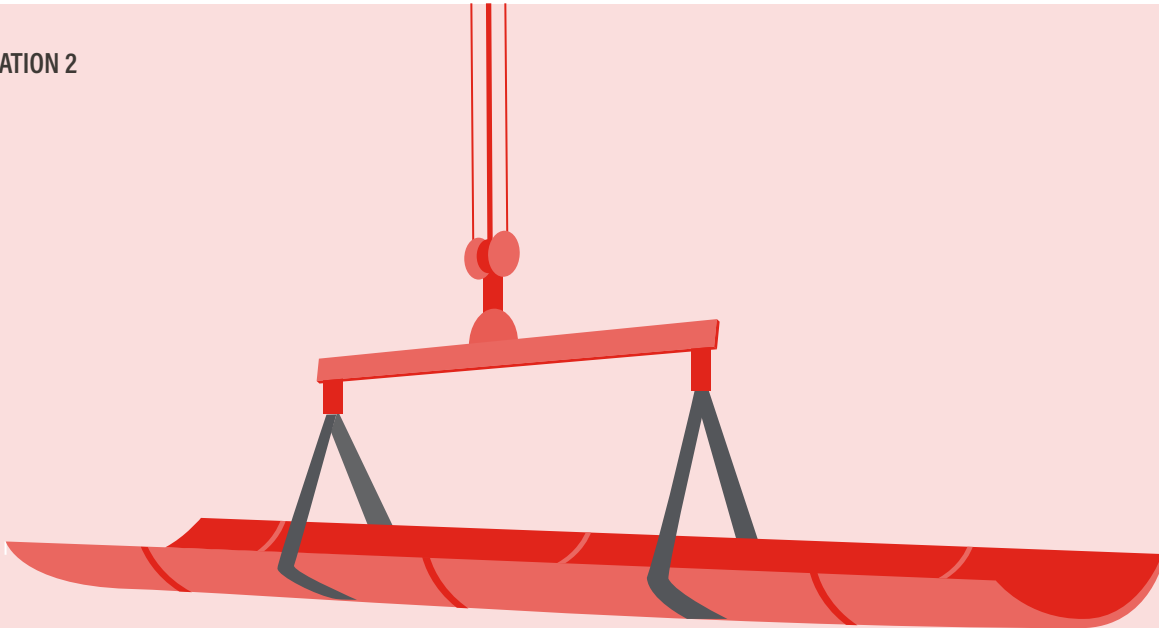

- **Protective Film:** If your metal panels come with protective film, the film must be removed promptly before panels are exposed to direct sunlight and/or high temperatures. After exposure to heat or sunlight, this film cannot be removed. Never leave protective film on panels after installation. Metal supplier and metal fabricator cannot be held liable for damage to metal panels caused by improper storage or failure to remove protective film.
- **Touch-Up Paint:** Painted panels, trim and flashings are made with a factory-applied heat-cured finish. During handling and installation, a panel may become slightly scratched or nicked. Your supplier may offer touch-up paint in matching colors. It is recommended that contractors order matching touch-up paint at the time of original metal panel order for best matching.

Limit application of touch-up paint to the exact area in need of repair with as little paint as necessary. Do not paint over panel finish with brushes that are too large for the affected area. Consider use of small artist's brush or cotton swab for improved application control. While aerosol touch-up paint may be available, its use can cause significant overspray and is not as durable. Note that touch-up paint does not have the superior chalk and fade resistance of a factory-applied finish and will likely discolor at an accelerated rate. Due to the limitations and formulation of field-applied touch-up paint, no warranties apply to its use.



## Important Information for Architect, Engineer, Contractor & Installer

It is the responsibility of the designer/engineer to ensure that the following details are adapted to meet the conditions encountered within any particular building design when using the products and specifications described herein, including governing product approvals and building codes. Contact your supplier if local, controlling codes or insurance requirements conflict with recommendations in this guide. Please familiarize yourself with all instructions before starting metal panel installation.

- **Ordering and Measuring for Metal Panels:** Material estimates can typically be created from satellite imagery, blueprints/drawings, or a sketch with dimensions. For specific information on estimating materials or other information needed to place an order for your specific project, contact your metal panel supplier.

### Accurate Field Measurements= Quality Installation Measure > Verify Cut Sheets > Check Accuracy > Release to Production

It is always recommended that panel lengths, quantities, profiles and dimensions of flashings are verified through field measurements and checked for accuracy against cut sheets or other documents prior to approving your metal panel order for production.

- **Roof Deck:** It is the responsibility of the contractor/installer to ensure that the roof deck is properly prepared and meets all applicable code requirements prior to panel installation. The deck should be examined to ensure that all supporting members are straight, level and plumb to prevent any panel distortion. Potential problems should be reported in writing to the general contractor, architect, or owner and work to install metal panels should not begin until all unsatisfactory conditions have been corrected. In general, the appearance of installed metal panels will follow the form of the roof deck. The surface should be smooth, straight, and free of humps and depressions. Any surface imperfections will be transferred through the roof panel and likely visible after the roof is installed. Check for and correct uneven decking, ridges in underlayment and other protruding areas. A solid deck should also be swept clean and be free of any fasteners, litter, or debris. Panel distortions caused by improper handling, ridges in underlayment, uneven decking, construction debris, etc. are not cause for rejection of metal panels.





- **Delivery and Receiving:** Refer to the *Product Safety and Handling* section on pages 5-7 of this guide for important information about delivery, receiving and handling of metal panels.

- **Before Start of Installation:** When starting metal panel installation, ensure panels are held true, plumb and straight. Panel widths are typically nominal, and it is recommended that periodic measurements be taken to ensure horizontal spacing is not gaining or losing width.

- **Field Cutting:** Some field cutting and fitting of metal panels and trims, as well as minor field corrections are a part of normal installation work and should be planned for. Metal Alliance recommends the use of tin snips or a “nibbler” type electric tool for field cutting panels. Circular saws, torches, and plasma cutters should not be used. All metal shavings and/or filings must be removed from panels and flashing each day to avoid rusting metal surfaces which could shorten metal roof life and void any applicable warranties. Always do a final check for any filings at the end of project to ensure removal.

- **Dissimilar Metals:** When using dissimilar metals and/or pressure-treated wood, a separation barrier must be used to prevent contact between them to avoid corrosion. Fasteners installed into pressure-treated lumber should be tested and approved for use. Approved fasteners are Series 300 stainless steel, hot-dipped galvanized, or fasteners coated with an approved coating capable of resisting the corrosive effects of pressure-treated lumber.

- **Fasteners:** Proper fastener installation is critical to ensure performance of a metal roof. Fasteners and spacing patterns should follow recommendations in this guide, applicable product approvals and building codes governed by the jurisdiction of the project. Over or under-tightening of fasteners can reduce performance or result in a wavy panel. Metal shavings or fragments resulting from fastener installation should be completely removed from panels daily to avoid rusting.



**Important  
Information  
About Oil Canning**

**Oil canning can be described as the amount of waviness found in the flat area of metal panels. Oil canning is an inherent characteristic of light-gauge, cold-formed metal products, does not affect the integrity of the panel, and is not a cause for rejection. Designers may consider narrower panel widths, heavier gauge metal, and the use of stiffening ribs or striations as potential means to minimize oil canning. Installers should take care to use proper torque when installing fasteners to reduce waviness as well.**



- **Sealants:** Sealant used in joints, flashings and seams shall be the sealant used in testing, details of which can be found in the applicable product approval. Sealant should be field applied on clean, dry surfaces without any skips or voids in the bead.

- **Trims, Closures and Accessories:** For trims, closures and accessories shown on installation detail drawings herein, contact your metal panel supplier.



**Product Installation Checklist**

<p><b>RIDGE CAP</b></p> <p>5-3/8" 3/8"</p>	<p><b>VENTED RIDGE CAP</b></p> <p>100 Specify Angle 1/2" Flat Hems</p>	<p><b>VALLEY</b></p> <p>Specify Slope 1" V 6"</p>
<p><b>GABLE RAKE #1</b></p> <p>5/8" 1" Flat Hem a b</p>	<p><b>GABLE RAKE #2</b></p> <p>5/8" 1" Flat Hem a b Open Hem</p>	<p><b>EAVE DRIP</b></p> <p>a Color 90° b 3/8" - 1/2"</p>
<p><b>EAVE DRIP SLOPED</b></p> <p>a Color Specify Slope b 3/8" - 1/2"</p>	<p><b>PEAK CAP</b></p> <p>a Specify Slope b</p>	<p><b>HEADWALL FLASHING</b></p> <p>4" Color Specify Slope 5" 5/8"</p>
<p><b>SIDEWALL FLASHING</b></p> <p>4" Color 5" 5/8" 1" Flat Hem</p>	<p><b>J CHANNEL #1</b></p> <p>5-1/4" 3/4"</p>	<p><b>J CHANNEL #2</b></p> <p>4"</p>

The items listed are for a typical installation. Installers should determine products required for a specific project based on applicable regulations, product approvals, building codes, and accepted industry practices.



**Product Installation Checklist**

<p><b>STUCCO STOP COUNTERFLASHING</b></p> <p><input type="checkbox"/></p>	<p><b>SURFACE MOUNT COUNTERFLASHING</b></p> <p><input type="checkbox"/></p>	<p><b>REGLET COUNTERFLASHING</b></p> <p>Color <input type="checkbox"/></p> <p><input type="checkbox"/></p>
<p><b>STANDARD CLEAT</b></p> <p><input type="checkbox"/></p>	<p><b>5V CRIMP PANEL</b></p> <p><input type="checkbox"/></p>	<p><b>UNDERLAYMENT</b></p> <p>Palisade Synthetic <input type="checkbox"/></p> <p>Peel &amp; Seal Self Stick <input type="checkbox"/></p> <p>Ultra HT Wind &amp; Water Seal <input type="checkbox"/></p>
<p><b>CLOSURES</b></p> <p>Inside Closure <input type="checkbox"/></p> <p>Outside Closure <input type="checkbox"/></p> <p>Universal Closure <input type="checkbox"/></p>	<p><b>TUBE SEALANT</b></p> <p>Bostik ChemCalk 915 <input type="checkbox"/></p> <p>Geocell 2320 <input type="checkbox"/></p> <p>TiteBond WeatherMaster Polymer <input type="checkbox"/></p>	<p><b>INSULATION</b></p> <p>Single Bubble <input type="checkbox"/></p> <p>Double Bubble <input type="checkbox"/></p> <p>MaxTight Air Barrier System <input type="checkbox"/></p> <p>Opti-Liner High R Banded Liner <input type="checkbox"/></p>
<p><b>TAPE SEALANT</b></p> <p>Butyl Tape <input type="checkbox"/></p> <p>Peel &amp; Seal Tape <input type="checkbox"/></p>	<p><b>PENETRATIONS</b></p> <p>Pipe Boot <input type="checkbox"/></p> <p>Retro-fit Boot <input type="checkbox"/></p>	<p><b>RIDGE VENT</b></p> <p>ProfileVent <input type="checkbox"/></p> <p>Razorback Universal <input type="checkbox"/></p>

The items listed are for a typical installation. Installers should determine products required for a specific project based on applicable regulations, product approvals, building codes, and accepted industry practices.

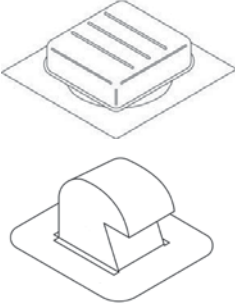
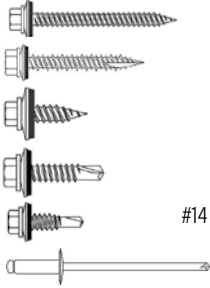

**Product Installation Checklist**

<p><b>METAL SNIPS</b></p>  <p>                     Straight L/R <input type="checkbox"/>                      Offset L/R <input type="checkbox"/>                      TurboShear Drill Attachment <input type="checkbox"/> </p>	<p><b>VENT</b></p>  <p>                     Attic Breeze                      20w <input type="checkbox"/>                      30w <input type="checkbox"/>                      40w <input type="checkbox"/>                      Gooseneck Vent                      Alum Steel                      4" <input type="checkbox"/> <input type="checkbox"/>                      6" <input type="checkbox"/> <input type="checkbox"/>                      10" <input type="checkbox"/> <input type="checkbox"/> </p>	<p><b>FASTENERS</b></p>  <p>                     #9 HWH <input type="checkbox"/>                      #10 HWH <input type="checkbox"/>                      #12 HWH <input type="checkbox"/>                      #12 HWH Self-Driller <input type="checkbox"/>                      #14 HWH Self-Driller Stitch <input type="checkbox"/>                      SS Pop Rivet                      Stainless Steel <input type="checkbox"/> Painted <input type="checkbox"/> </p>

The items listed are for a typical installation. Installers should determine products required for a specific project based on applicable regulations, product approvals, building codes, and accepted industry practices.



Metal panel roofing is designed to provide trouble-free performance for years, with little service required. However, damage can occur from the build-up of debris as well as storm-related damage like hail stones and falling branches. The following maintenance guidelines consist primarily of preventing and correcting these issues. Contractors and installers should familiarize themselves with this information and ensure that building owners understand the minimum maintenance recommended to prolong the beauty and protective properties of their metal roof.

## Routine Maintenance

Routine visual inspection helps to identify potential problems. This can easily be done by simply walking around the building to look for accumulated debris or possible damage. It is recommended that the building owner do this at least twice a year. After a major weather event is another good time to inspect the roof to identify potential problem areas. **Caution: The use of binoculars is recommended so inspection can be done from the ground. If assessing damage from the ground is not possible, building owners should strongly consider hiring a professional trained in the safety precautions and proper maintenance of metal roofing.**

### **Additional steps building owners can take to prolong the life of their metal roof include:**

- Eliminate any conditions that are causing water to pond and accumulate on roof panels.
- Keep an eye out for leaves, branches and other debris piled up on the roof, especially around valleys and protrusions such as vent pipes, skylights, etc.
- Keep gutters and downspouts maintained and clear of debris.
- Remove vegetation that may contact metal panels, including trees, branches or leaves, weeds, ivy, etc.
- Clean off dirt, mildew, stains, and other elements. (See *Cleaning Metal Panels* on page 15.)
- Promptly address scratches that appear to have penetrated the protective finish to the metal substrate.
- **When in doubt, building owners should contact a professional trained in the inspection, maintenance, repair and safety of metal roofing for their maintenance and cleaning needs.**



**A metal roof should be professionally inspected every four to five years. In coastal or humid areas like Florida that are more prone to corrosion and rust, professional inspections should be done more frequently to prevent any rust that might have started from spreading and causing structural damage to the metal panels. Refer to all finish and material warranties issued by your supplier for important maintenance and cleaning requirements for your specific metal panel project.**



## Cleaning Metal Panels

The coating systems on metal roofing are designed to be resistant to many elements found in the environment such as air pollution, acid rain and general airborne dirt. Although these finishes are extremely durable, a periodic cleaning to remove build-up of resins and other residue is a good idea to extend life of the coating and performance of a metal roof. A variety of methods for removal of surface deposits from metal roofing panels are available.

**IMPORTANT: Refer to care and maintenance guidance included in all applicable material and finish warranties prior to using any cleaning method on metal panels.**



**Building owners should use extreme caution if attempting to follow the cleaning instructions listed in this guide. The hiring of an experienced professional trained in the safety precautions and cleaning methods for metal roofing is highly recommended.**

## Routine Cleaning

- **Painted Finishes, Tedlar® PVF Film and Acrylic-Coated Galvalume®:** Simple washing with clean fresh water twice a year using a hose or low-pressure spray equipment (no more than 2500 psi) is usually adequate for routine maintenance of metal panels. To remove leaves and debris, using a leaf blower is a common choice, but a long-handled push-broom or a telescoping pole with a window cleaning brush will also do the job. Use caution not to scratch metal panels.
- **Copper:** Copper metal panels should be cleaned with clean, fresh water only. Do not chemically or abrasively clean copper metal panels. Do not use soaps, detergents or other cleaning agents.

## Tougher Stains

When heavy deposits of dirt or other contaminants dull metal roof surfaces, stronger cleaning methods may be necessary. In these situations, there are specific steps and methods that should always be followed so panels are not damaged as a result of cleaning. Contractors and installers should familiarize themselves with this information and ensure that property owners are provided with the information they need to properly maintain their metal roof. **Note: The following applies to painted finishes, Tedlar® PVF Film and Acrylic-Coated Galvalume® only. These instructions do not apply to copper.**

- **Detergent Solutions:** A 5% solution of commonly used commercial (non-industrial) detergents, such as Dawn®, will not have an adverse effect on painted metal panels. Use a cloth or soft brush for application. These solutions should be followed by liberal rinse of water.
- **Solvents:** For removal of non-soluble deposits like tar, grease, oil, paint, graffiti, etc., the solvents listed below can



be used. These products should only be used to spot clean affected areas and should not be used to clean the entirety of the metal roof. Follow with liberal rinse of clean water. **Caution:** Most organic solvents are flammable and/or toxic and must be handled accordingly. Keep away from open flames, sparks, and electrical motors. Always use adequate ventilation and wear protective clothing and goggles.

- **Isopropyl (rubbing alcohol)**
- **Mineral Spirits**
- **VM&P Naphtha**
- **Turpentine (wood/gum spirits)**

▪ **Chemical Solutions:** For removal of mildew and rust from metal panels, the following solutions are recommended.

◆ **Mildew:** In areas subject to high levels of humidity (like Florida), dirt and spore deposits can permit mildew growth to occur. The following solution is recommended to remove mildew:

- 1/3 cup Dry Powdered Laundry Detergent (such as Tide®)
- 1-quart Sodium Hypochlorite 5% solution (such as Clorox®)
- 3 quarts water

◆ **Rust Stains:** Depending on where a metal roof is located, rust stains can develop on the painted surface over time. Usually this occurs when uncoated metal pieces and particles (typically steel) come into contact with the painted metal panels. The solution listed below, used with caution, may assist in removing rust stains.

- 1-part Hydrochloric, Citric Acid or Muriatic Acid  
or Oxalic Acid or Vinegar
- Diluted with Ten Volumes of Water
- Limit Contact to Five Minutes

**All chemical solutions used to remove mildew or rust stains should be flushed thoroughly with large amounts of clean water.**



## When Using Detergents or Other Solvents

### Proper Equipment:

Do not use wire brushes, abrasives or similar cleaning tools which will mechanically erode the coating surface.

**Test:** Always test the cleaning agents listed in an inconspicuous area before use on a large scale.

**Disposal:** Please make sure you dispose of cleaning solutions in an environmentally friendly manner.

## Warranty Note

Misuse or abuse of any cleaning agents listed in this guide can result in voiding of applicable warranties for the surface affected. Refer to the finish and material warranties issued by your supplier for important information about proper cleaning and maintenance for your specific project.





## Repairs

- **Touch-Up Paint for Minor Scratches:** Metal panels can become scratched due to branches or other lightweight debris coming into contact with the roof. Tradespeople doing work unrelated to the metal roof can also inadvertently scratch it. Use the manufacturer's recommended touch-up paint to correct scratches as they can quickly degrade the surface protection and jeopardize the longevity of metal panels. It is recommended that touch-up paint is ordered at the same time as original metal panel order for best matching.

Limit application of touch-up paint to the exact area in need of repair with as little paint as necessary. Do not paint over panel finish with brushes that are too large for the affected area. Consider use of small artist's brush or cotton swab for improved application control. While aerosol touch-up paint may be available, its use can cause significant overspray and is not as durable. Note that touch-up paint does not have the superior chalk and fade resistance of a factory-applied finish and will likely discolor at an accelerated rate. Due to the limitations and formulation of field-applied touch-up paint, no warranties apply to its use.

- **Other Repairs:** Should metal panels become damaged due to storm or other impact, improper maintenance, or if panels have separating seams, holes, loose or missing fasteners, it is recommended that the building owner engage a metal panel repair specialist to make the necessary repairs.



Prior to installation of a metal panel roofing system, the installer should familiarize themselves with the information in this guide. The installer should examine the roof deck to ensure that all supporting members are straight, level and plumb before work begins. Applicable product approvals, building codes, and accepted industry practices governing the project's jurisdiction should be verified. Contact your metal panel supplier when local, controlling codes or insurance requirements conflict with recommendations in this guide.

## Order of Installation

The direction and sequence of metal panel installation may vary from installation to installation based on a variety of conditions, including geographic factors, panel design, structural characteristics and aesthetic requirements. Proper planning of panel layout can save material, time, and labor and is always recommended. The steps below represent a typical installation. Contact your metal supplier for assistance with your specific installation if needed.

### Typical order sequence for installing metal panels:

- Underlayment
- Drip edge, valley flashing, and inside closure (closure should be installed simultaneously with panels)
- Metal panels
- Transition (pitch break) flashing (if required by roof design)
- Outside foam closure, universal closure, ridge and hip cap, gable rake trim, headwall and sidewall flashing

## Panel Installation

Once all underlying metal trim/flashing is installed, panel installation can begin. 50AIV metal roofing panels have a specific underlap and overlap side. The underlap side has a small flat area (anti-siphon channel) between two ribs. The overlap side does not have this flat area. To ensure panels are installed correctly and perform as expected, the overlap side of a panel should always be installed over the anti-siphon channel (underlap) side of the previous panel.

Panel installation should begin with the overlap side of metal panel along the gable. Where possible, it is recommended that the panel be installed so that the open side (overlap) faces away from the prevailing wind. The first panel is typically started by first placing an inside closure on eave flashing. Ensuring the inside closure is square with the roof, the panel is placed over the inside closure and attached to the roof deck using fasteners and spacing per product approvals. It is critical that the first panel is set square to the eave and ridge since it will be used as a baseline and reference for remaining panels. If the first panel is not set square, subsequently installed panels will also not be square impacting not only appearance, but long-term performance of the metal roof.

Install the second panel by positioning its overlap side on top of the underlap side of the previously installed panel, again ensuring that it is flush and square at the eave with the previous panel. Using approved fasteners and



spacing patterns, attach the first and second panels together at the lapping rib, and the second panel to the roof deck per product approvals. Continue this process across the roof section until the gables/ends are reached on both sides.



**As panel widths can nominally vary, it is recommended that periodic measurements be taken to ensure horizontal spacing is not gaining or losing width.**

### Fastener Installation

The installation of exposed fastener 5V panels relies on the use of fasteners (screws) that penetrate through metal panels to attach them to both the substrate and to each other. Because holes must be made in the panels at each fastener location, it is critical that each fastener is properly installed and sealed for maximum roof performance. Fastener type, quantity, and spacing should be installed in accordance with product approvals and building codes governing the project's jurisdiction. **Incorrect fastener material, type, and installation shorten roof life.**

**NOTE: IMPACT DRIVERS ARE NOT RECOMMENDED AS THEY MAY OVERDRIVE OR DAMAGE FASTENERS.**

While pre-drilling holes for screws in metal panels is not required, it can make achieving even, straight lines of fasteners easier and make the roof look better from the ground. If the decision is made to pre-drill fastener holes, use a cover sheet to prevent hot metal shavings from sticking to panels and consider pre-drilling from underside. Always ensure pre-drilling measuring is done accurately.

## Straight + Firm Installation = Properly Driven Fastener

• **Straight Fastener Installation:** Fasteners should always be driven straight (Exhibit 1), properly sealing the penetration made by the fastener and holding metal panels in place. If not straight, the head/washer will not seat firmly (flat) to the panel surface, resulting in an improper seal and gaps which can leak. An improperly driven fastener also means less surface and uneven pressure trying to hold panels in place, creating a weak connection that can lead to premature failure.

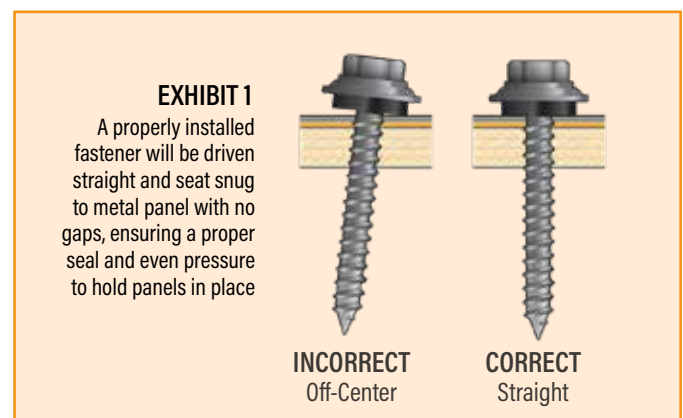

• **Firm Fasteners:** A properly driven fastener will also be tight (firm) against the surface, allowing the rubber washer to effectively become a gasket between the metal panel and screw (Exhibit 2). This keeps panels in place and water out. Under-driven and over-driven fasteners can both lead to corrosion, leaking and other impacts that threaten the integrity of the roof.



- Under-Tightened Fasteners:** When a washer does not make contact with the panel, it can not seal properly allowing water to flow in around the screw penetration. When loose, a fastener head will also not have the strength (pressure) needed to hold the panel in place. This unintended movement can cause panel distortion and damage and may lead to failure of the roof. Under-tightened fasteners are easily corrected by re-tightening to the correct firmness.

- Over-Tightened Fasteners:**

Overdriven fasteners deform and distort the material they are holding in place, creating pockets for moisture and water that can lead to metal panel corrosion and leaking. Over-tightening also over-compresses washers and adhesive reducing sealing ability around the fastener. Correcting an over-tightened fastener is not simply a matter of "un-tightening" the fastener, as this creates gaps and loss of holding pressure. Replacement of the over-tightened fastener is required and should include additional sealant, a change in gasket, and a different size replacement fastener as needed. If distortion or damage is too severe, replacement of the metal panel may be necessary.

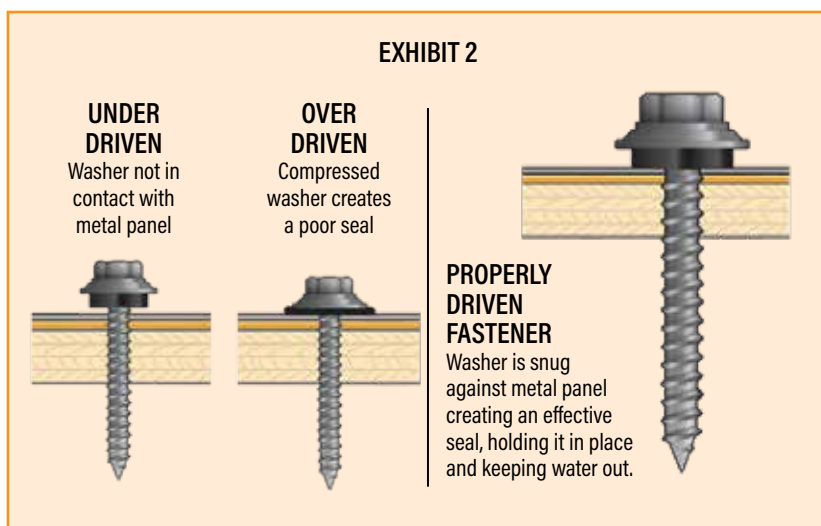

### ADDITIONAL FASTENER INSTALLATION TIPS

- For optimal installation:** Use an appropriate screw gun with a depth-sensing or torque-control feature. Using a variable-speed screw gun will allow for adjustments as necessary to accommodate hard areas of steel or inconsistent thicknesses.
- To prevent wobbling:** Make sure fastener head is completely engaged in the socket. If needed, tap the magnet deeper into the socket to allow full head engagement. Use high-quality nut-setters and insert bits. Worn out nut-setters/insert bits should not be used as this can cause fastener damage.
- Protect drill point:** Correct pressure will allow fastener to drill and tap without binding. To prevent too much friction and burn out of the drill point, apply only enough pressure on the screw gun to engage clutch.
- Drilling through sheet and insulation:** Ease up on pressure when drilling through insulation to avoid striking the purlin or girt with the point - apply more pressure after drill point contacts purlin or girt.



**Fastener Patterns**

Fastener quantity and spacing will vary depending on metal type and strength. Spacing will also likely vary at different parts of a roof due to different uplift stress these areas experience. Always follow fastener patterns governed by applicable product approvals and building codes of each project's jurisdiction.

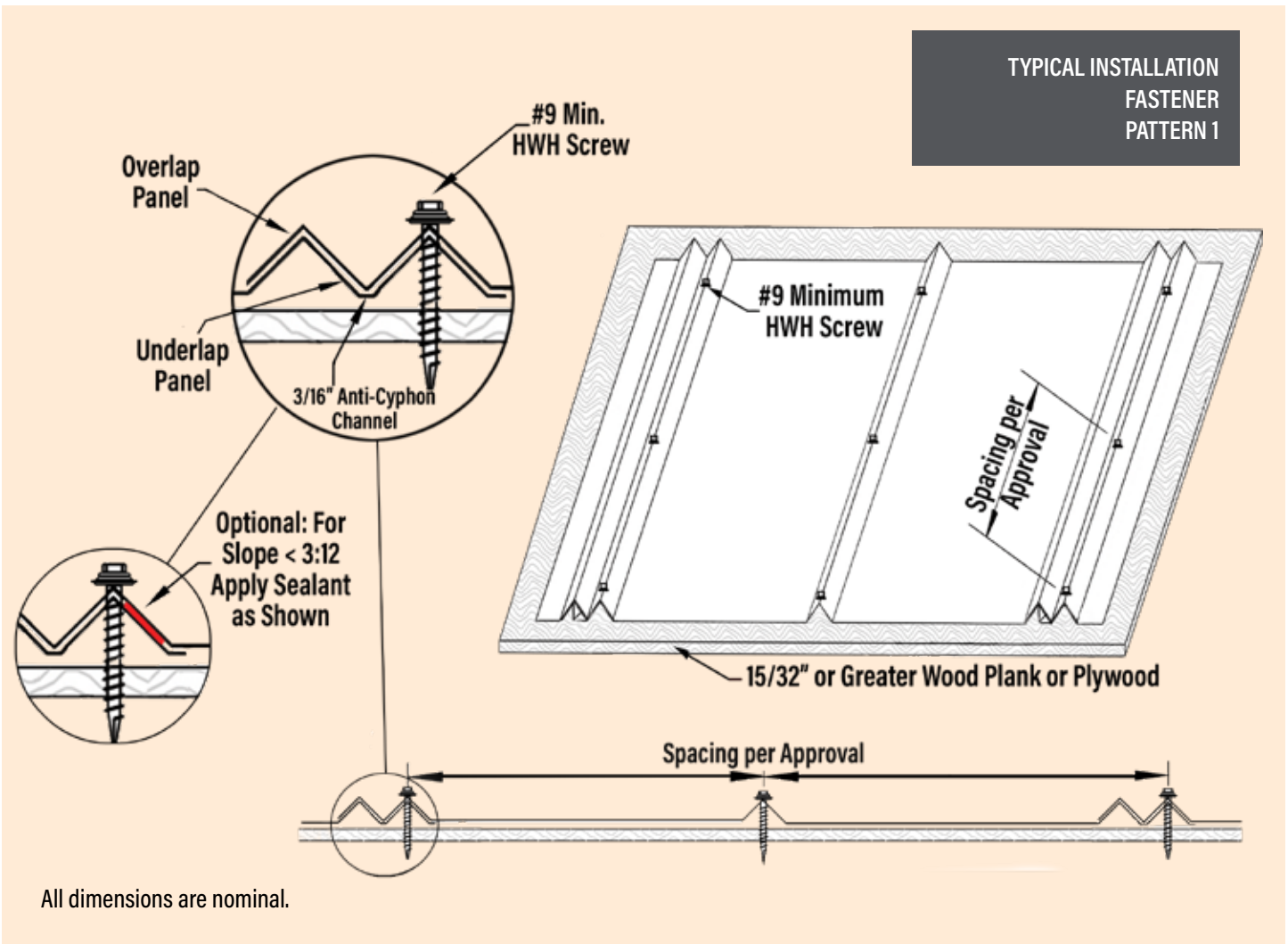

Actual fastener patterns may vary from the fastener patterns shown here based on the specific roof plan, local building codes and applicable product approvals.

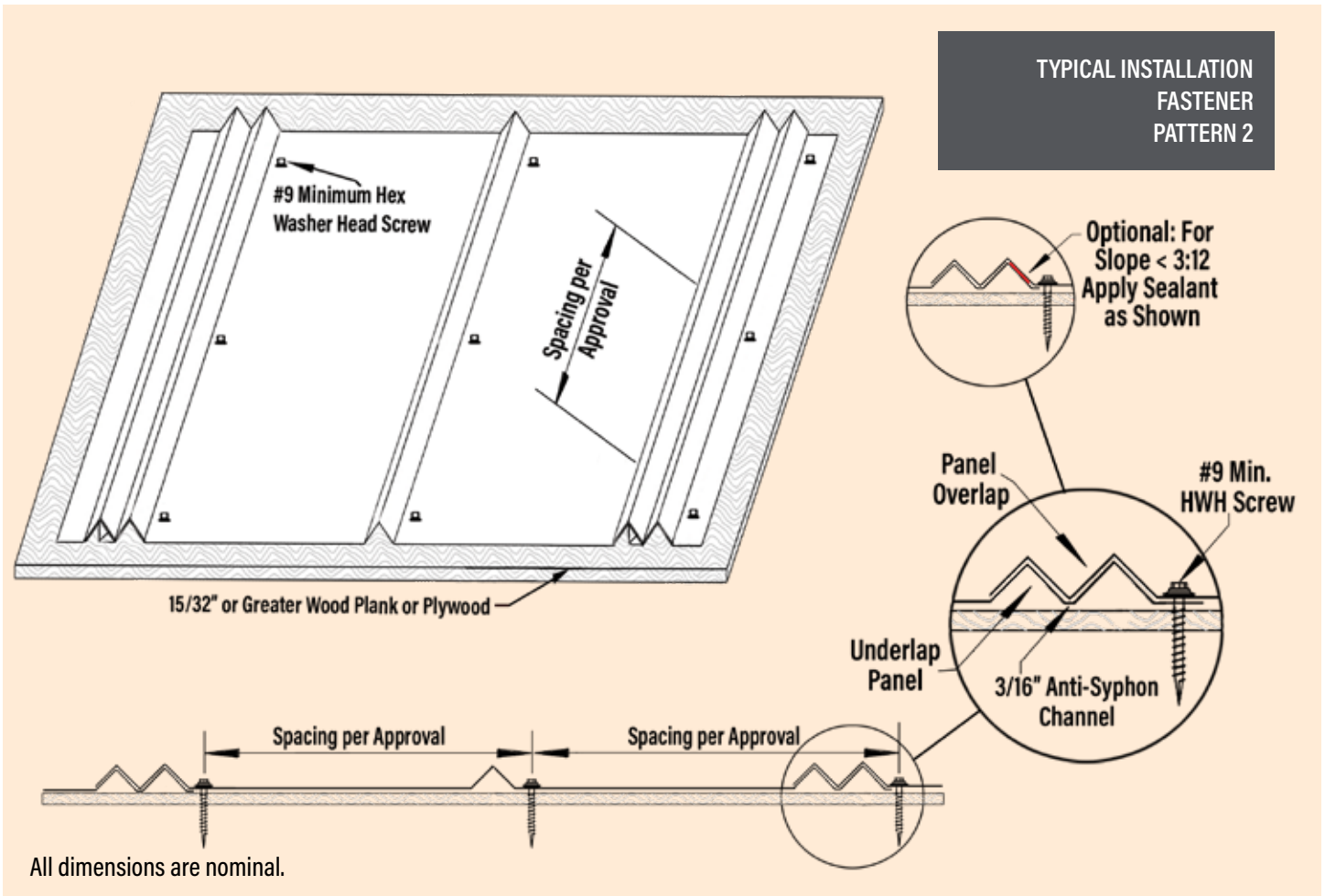

### Field Cutting

Field cutting and fitting of metal panels and trims is usually required. When field cutting panels, use tin snips or a "nibbler" type electric tool. Properly using these tools will deliver the cleanest cuts, cause the least damage, and leave minimal rough edges. Circular saws, torches, and plasma cutters should not be used. Always wear protective gloves and stay clear of cutting blades.

When possible, locate field cuts away from weather. If a roof panel has to be trimmed to length, trim the top of the panel where the cut will be hidden from the weather with a ridge flashing. When it is necessary to cut an eave flashing to length, put the field cut end beneath the factory cut end of the adjacent section.



**Remember to remove all metal shavings and/or filings created from field cutting or fastener installation from panels and flashings each day to avoid the development of rust.**

# Installation Details

---

The detail drawings in this guide are for a typical installation. It is the installer's responsibility to determine and select the details and specifications that are appropriate for each project. **As the requirements of each project will vary, Metal Alliance does not warrant the fitness or suitability of the details contained herein for any specific project.** For specific advice on design, installation details, code compliance, or feasibility of use for a particular project, consult your metal panel supplier or a design professional.

# Fixed Ridge/Hip Detail

Detail No. **E-RH1-V** NOT TO SCALE

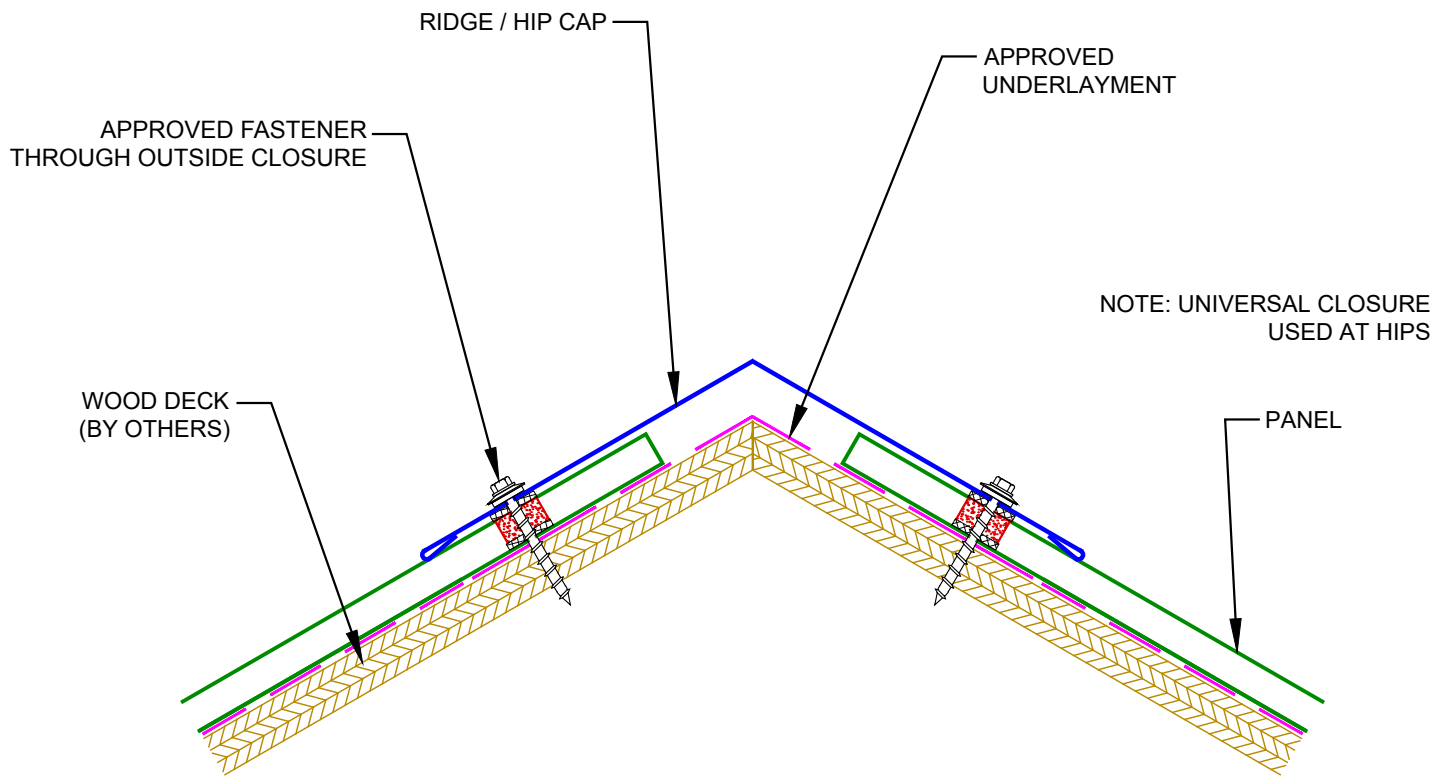

**OPTION:** 6" WIDE PEEL AND SEAL TAPE IS AVAILABLE TO SEAL OVER PANELS PRIOR TO INSTALLING RIDGE CAP.

Rev. 12/21

Copyright © 2021 by Metal Alliance Supply LLC. All rights reserved. No part of this document may be reproduced, distributed, or transmitted in any form or by any means, including photocopying, recording, or other electronic or mechanical methods, without the prior written permission of Metal Alliance.



# Notched Ridge Detail

Detail No. **E-RH2-V** NOT TO SCALE

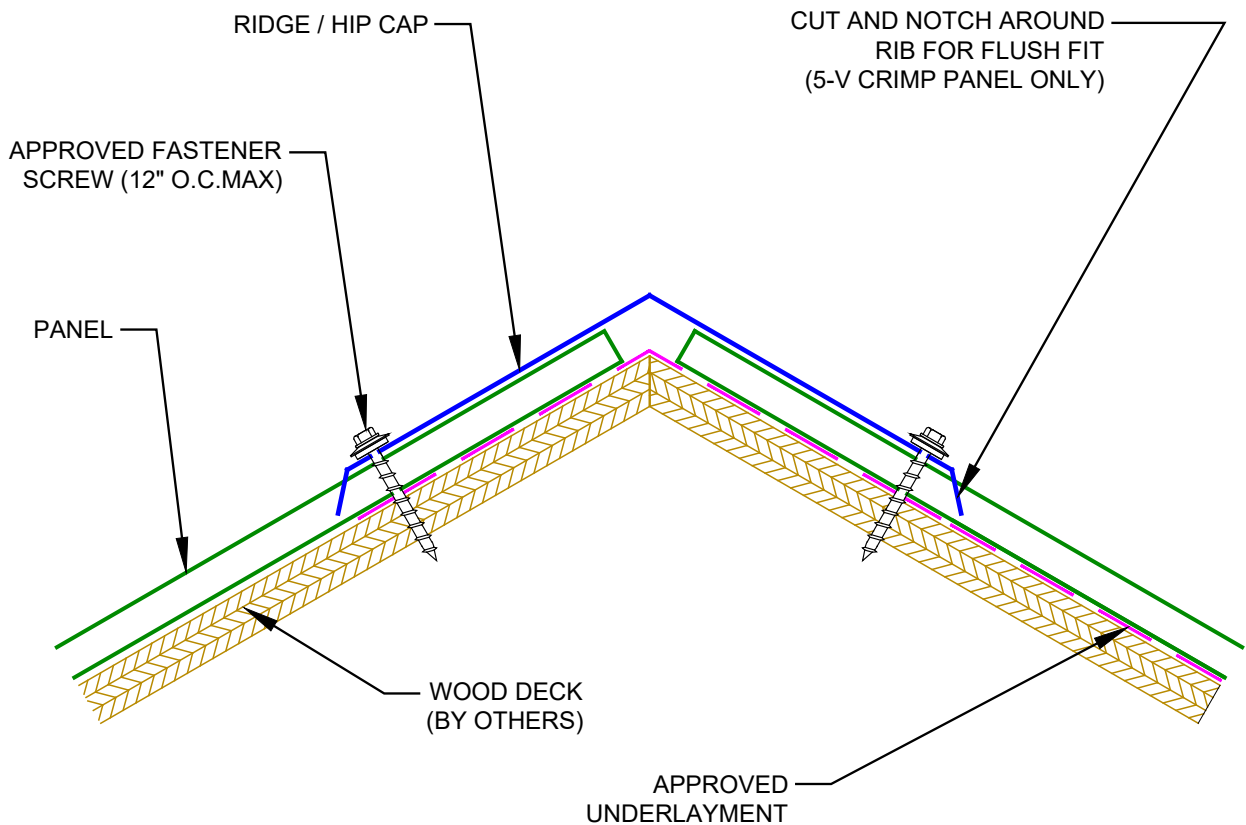

**OPTION:** 6" WIDE PEEL AND SEAL TAPE IS AVAILABLE TO SEAL OVER PANELS PRIOR TO INSTALLING RIDGE CAP.

**NOTE:** FOAM CLOSURES MAY STILL BE USED IN ADDITION TO THE NOTCHED RIDGE CAP.

Rev. 12/21

Copyright © 2021 by Metal Alliance Supply LLC. All rights reserved. No part of this document may be reproduced, distributed, or transmitted in any form or by any means, including photocopying, recording, or other electronic or mechanical methods, without the prior written permission of Metal Alliance.

# Vented Ridge Detail

Detail No. **E-VR1-V** NOT TO SCALE

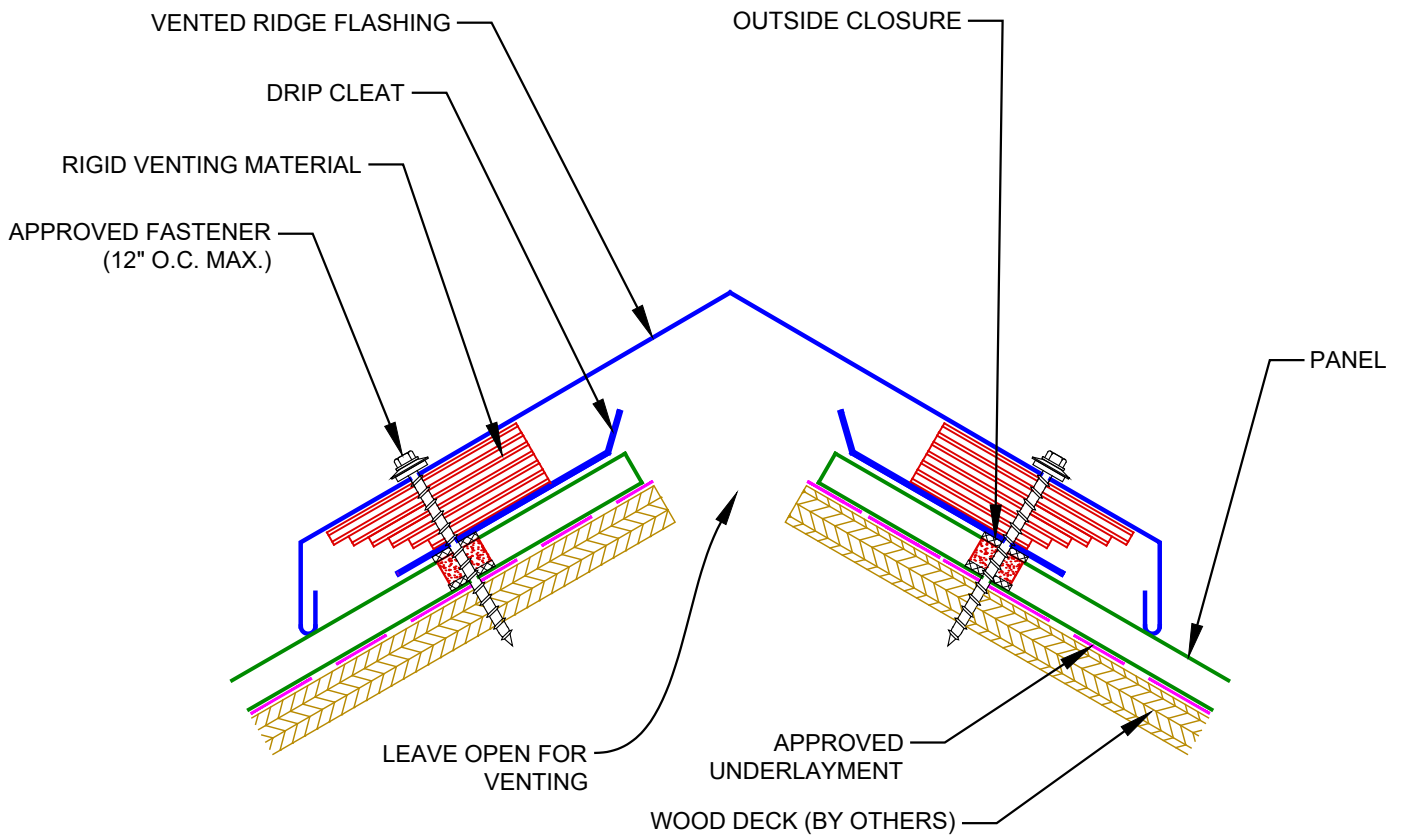

Rev. 12/21

Copyright © 2021 by Metal Alliance Supply LLC. All rights reserved. No part of this document may be reproduced, distributed, or transmitted in any form or by any means, including photocopying, recording, or other electronic or mechanical methods, without the prior written permission of Metal Alliance.

# Vented Ridge - Profile Vent Detail

Detail No. **E-VR2-V** NOT TO SCALE

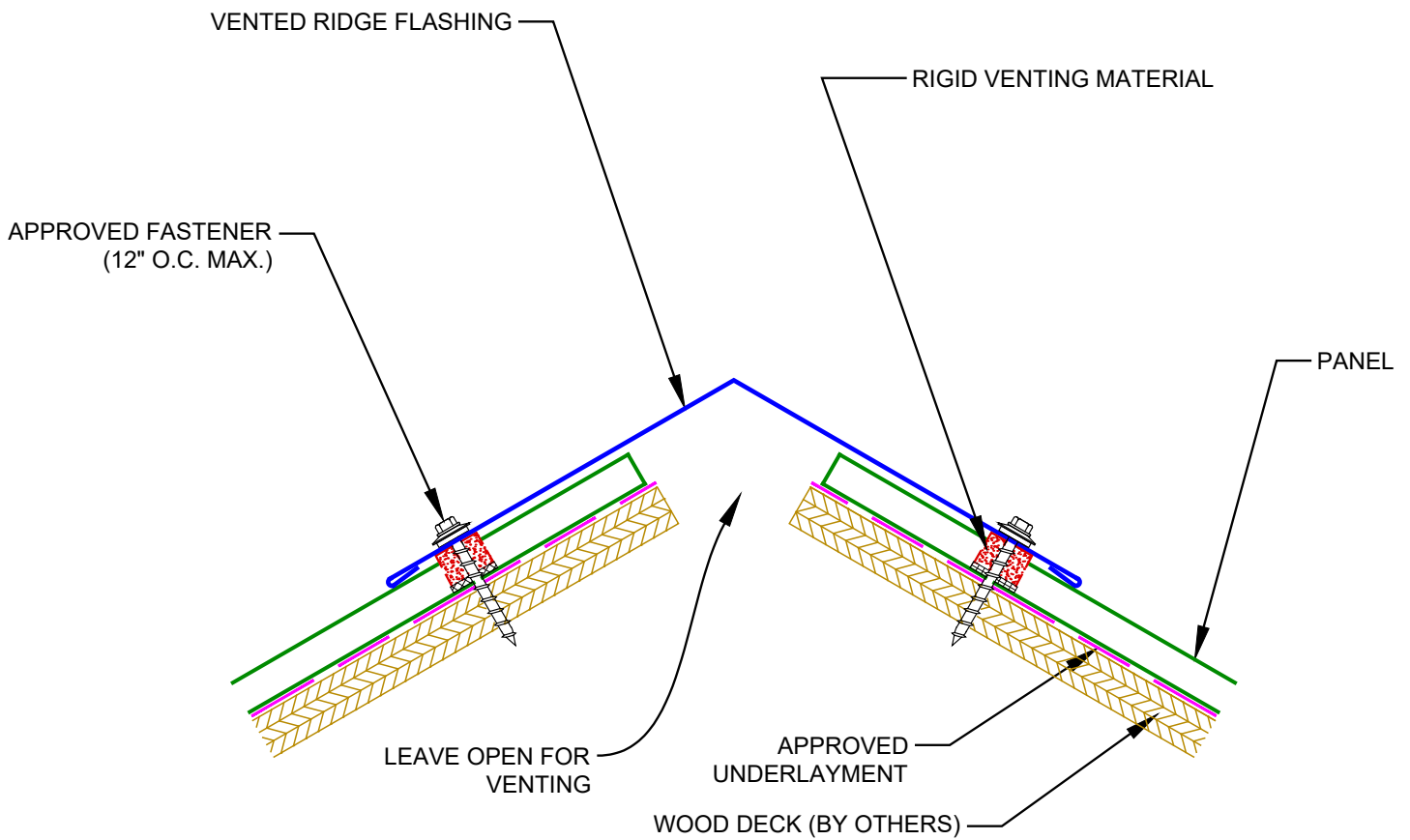

Rev. 12/21

Copyright © 2021 by Metal Alliance Supply LLC. All rights reserved. No part of this document may be reproduced, distributed, or transmitted in any form or by any means, including photocopying, recording, or other electronic or mechanical methods, without the prior written permission of Metal Alliance.

# Vented Ridge - Perforated Metal Vent Detail

Detail No. **E-VR3-V** NOT TO SCALE

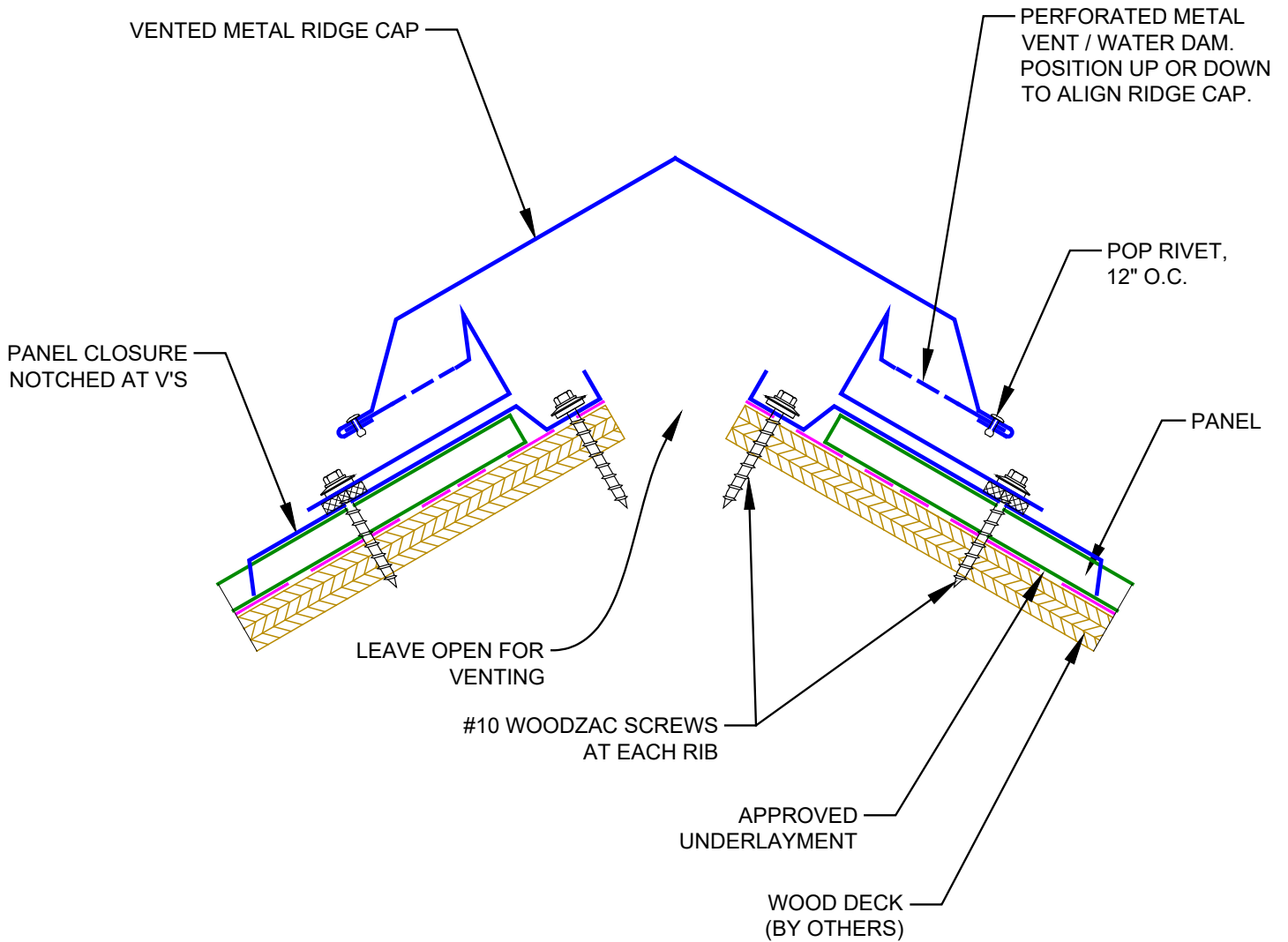

Rev. 12/21

Copyright © 2021 by Metal Alliance Supply LLC. All rights reserved. No part of this document may be reproduced, distributed, or transmitted in any form or by any means, including photocopying, recording, or other electronic or mechanical methods, without the prior written permission of Metal Alliance.

# Valley Detail

Detail No. **E-VF1-V** NOT TO SCALE

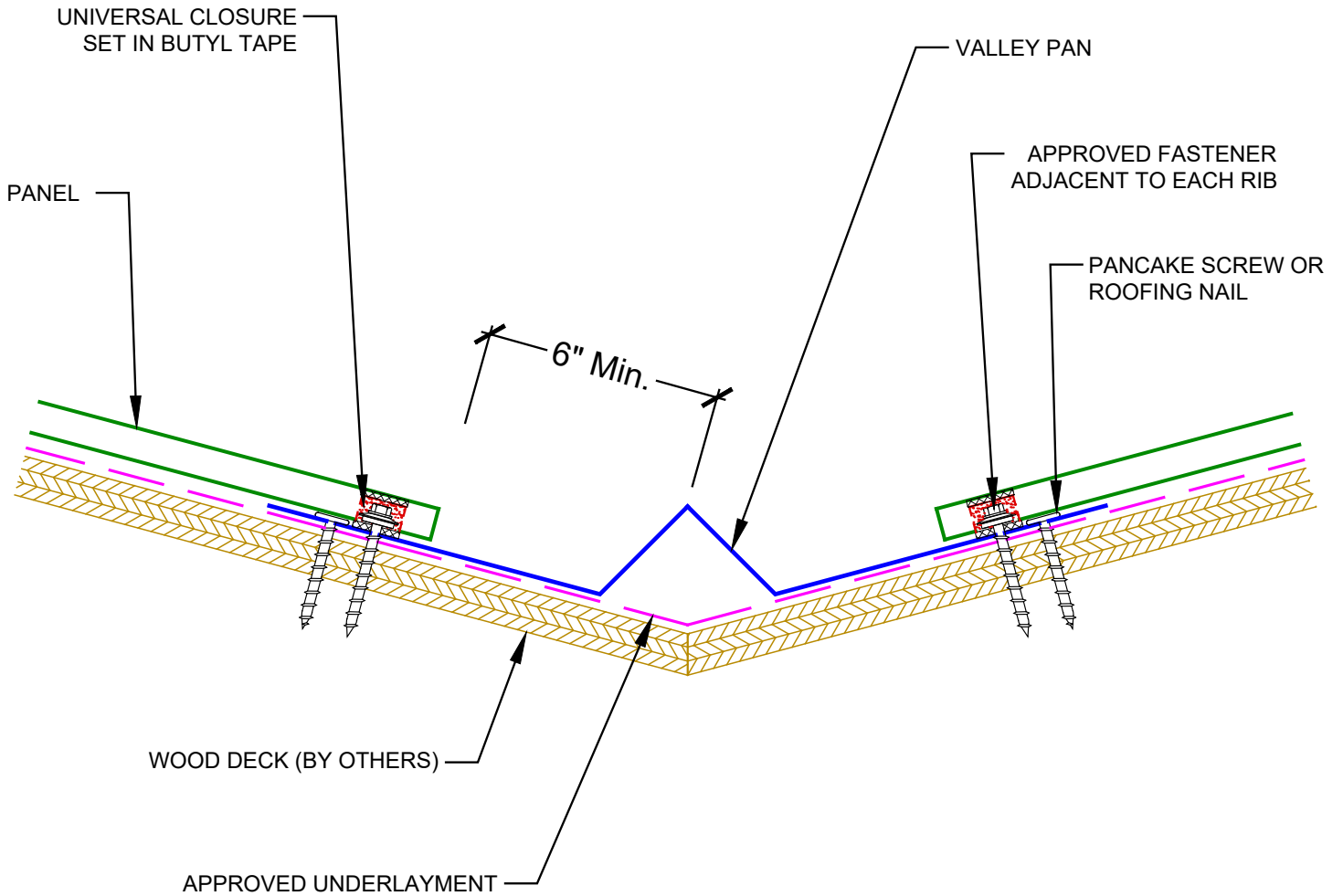

NOTE: FLASHING LAPS IN VALLEY ARE 6" MIN. USE TWO ROWS OF APPROVED TUBE SEALANT IN ALL LAPS.

Rev. 12/21

Copyright © 2021 by Metal Alliance Supply LLC. All rights reserved. No part of this document may be reproduced, distributed, or transmitted in any form or by any means, including photocopying, recording, or other electronic or mechanical methods, without the prior written permission of Metal Alliance.

# Eave Detail

Detail No. **E-ED1-V** NOT TO SCALE

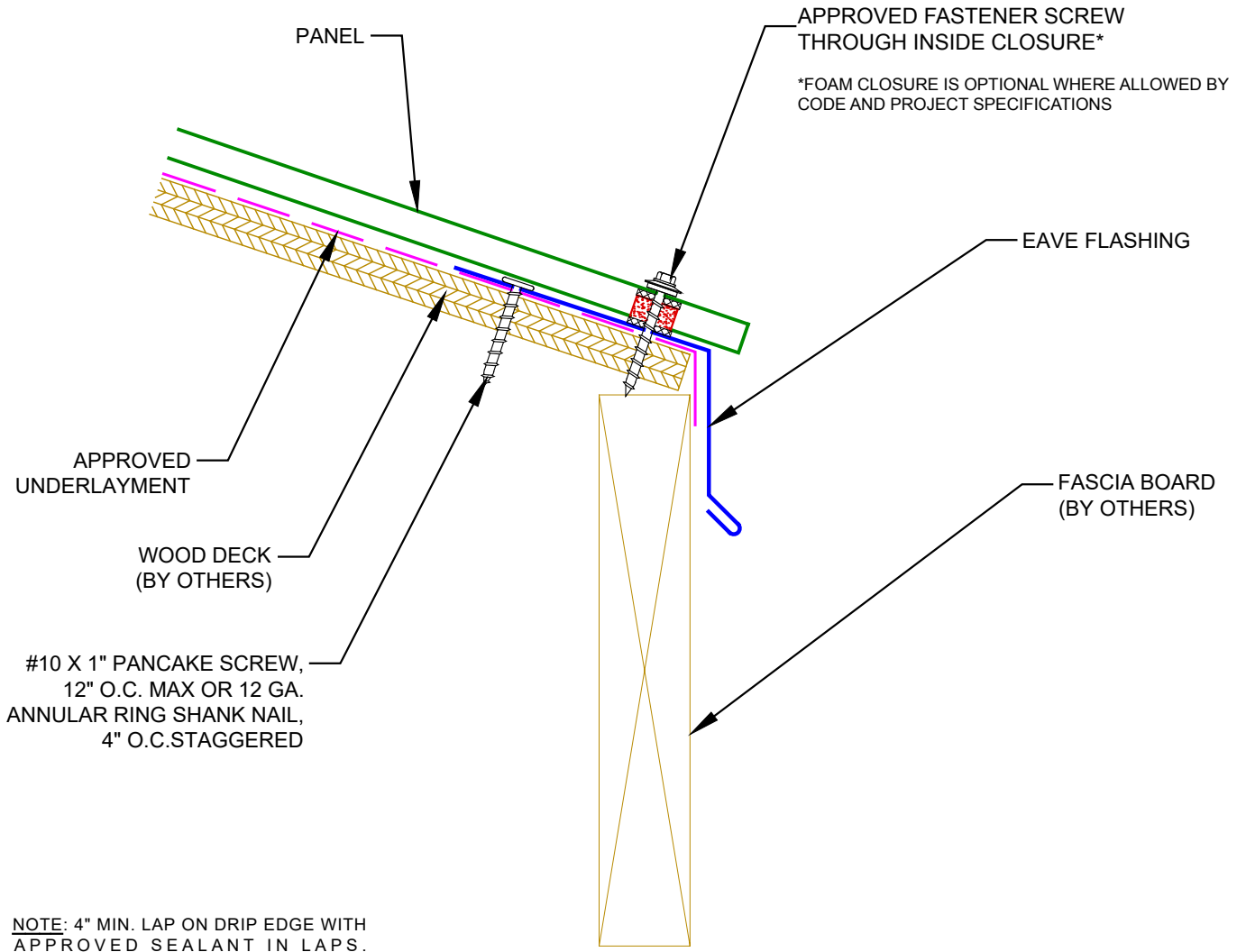

Rev. 12/21

Copyright © 2021 by Metal Alliance Supply LLC. All rights reserved. No part of this document may be reproduced, distributed, or transmitted in any form or by any means, including photocopying, recording, or other electronic or mechanical methods, without the prior written permission of Metal Alliance.

# Eave - Gutter Detail

Detail No. **E-EG1-V** NOT TO SCALE

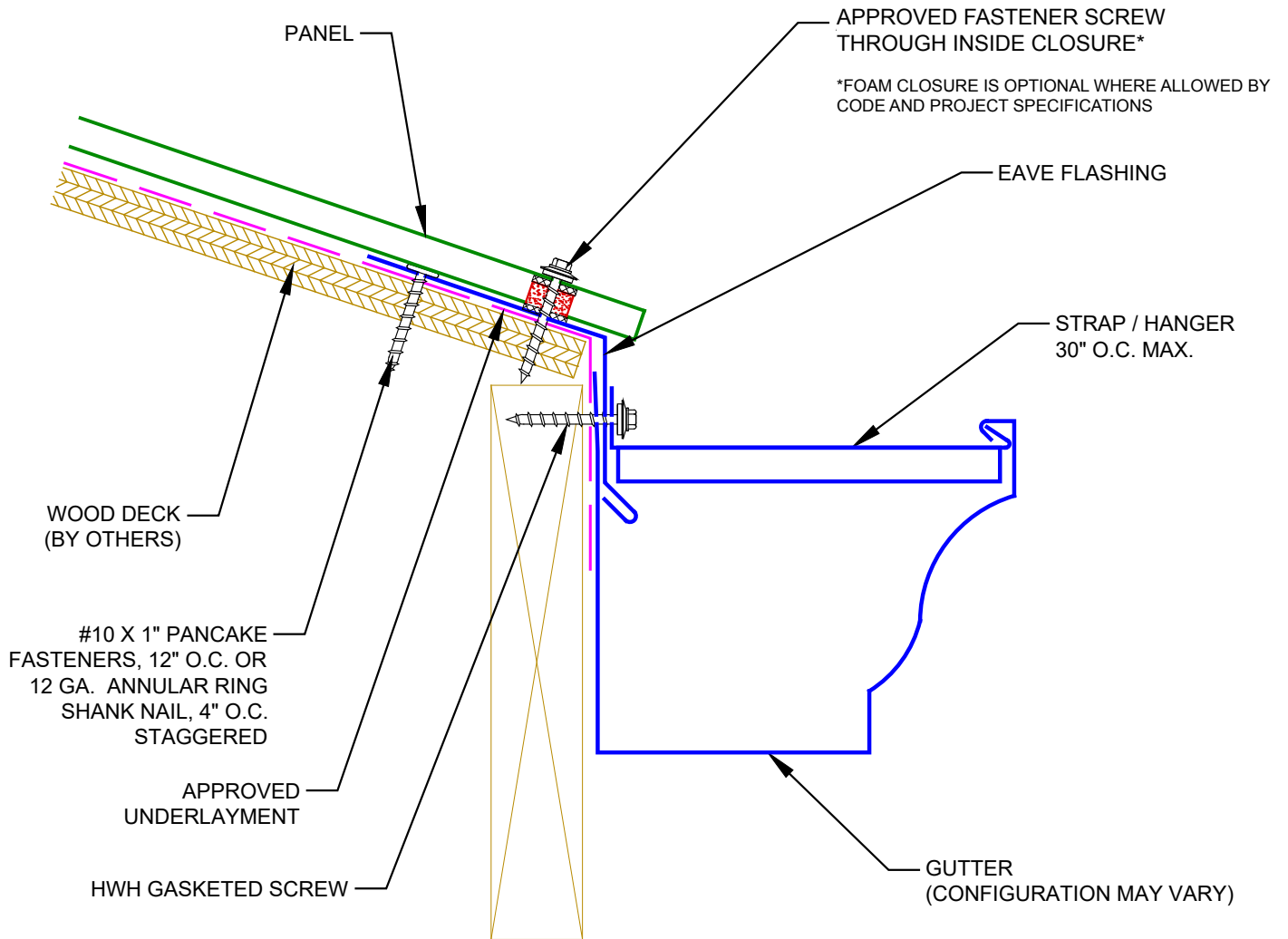

**NOTE:** 4" MIN. LAP ON DRIP EDGE WITH APPROVED SEALANT IN LAPS.

Rev. 12/21

Copyright © 2021 by Metal Alliance Supply LLC. All rights reserved. No part of this document may be reproduced, distributed, or transmitted in any form or by any means, including photocopying, recording, or other electronic or mechanical methods, without the prior written permission of Metal Alliance.

# Rake/Gable Detail

Detail No. **E-GR1-V** NOT TO SCALE

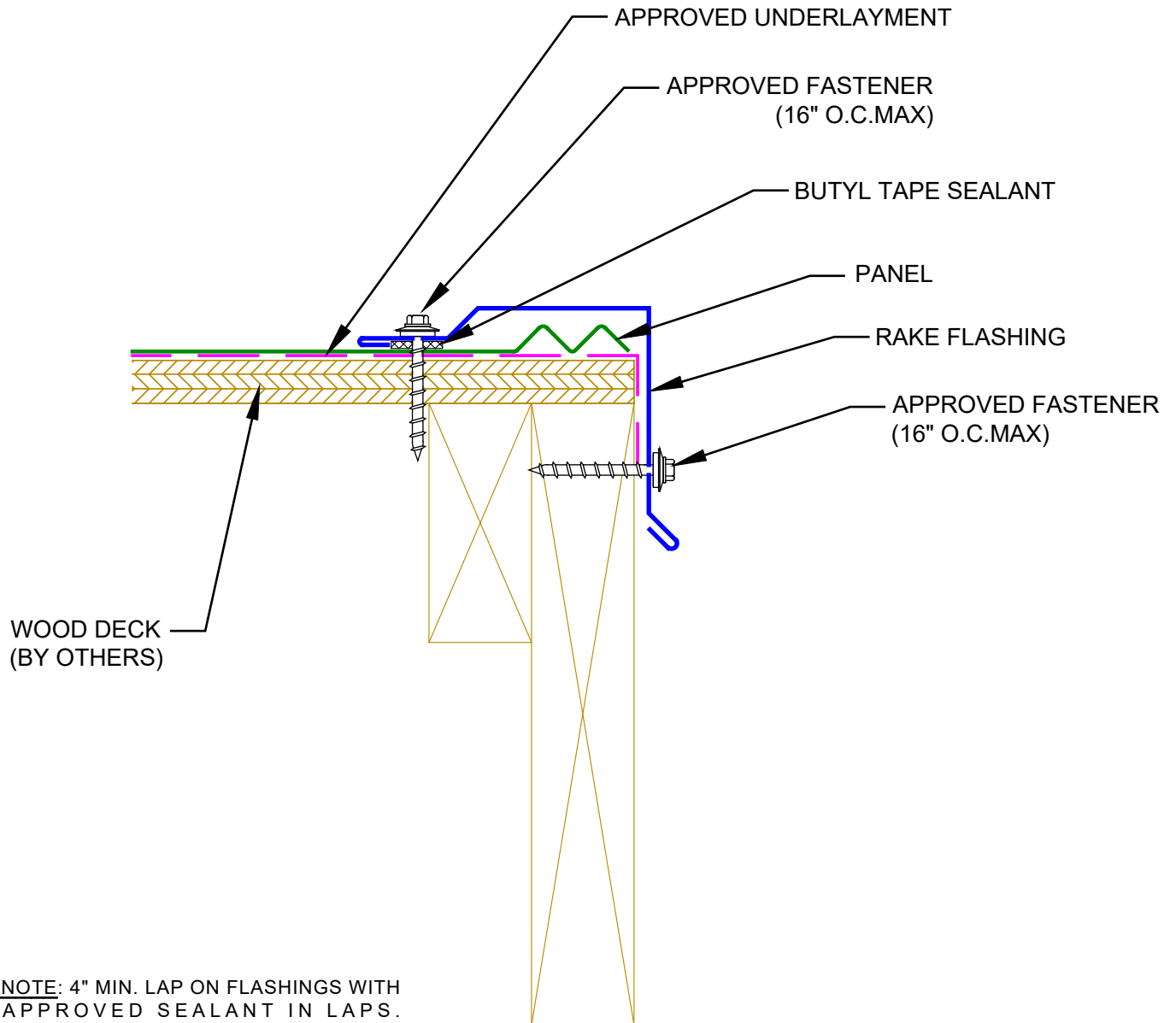

Rev. 12/21

Copyright © 2021 by Metal Alliance Supply LLC. All rights reserved. No part of this document may be reproduced, distributed, or transmitted in any form or by any means, including photocopying, recording, or other electronic or mechanical methods, without the prior written permission of Metal Alliance.



# Peak Detail

Detail No. **E-PK1-V** NOT TO SCALE

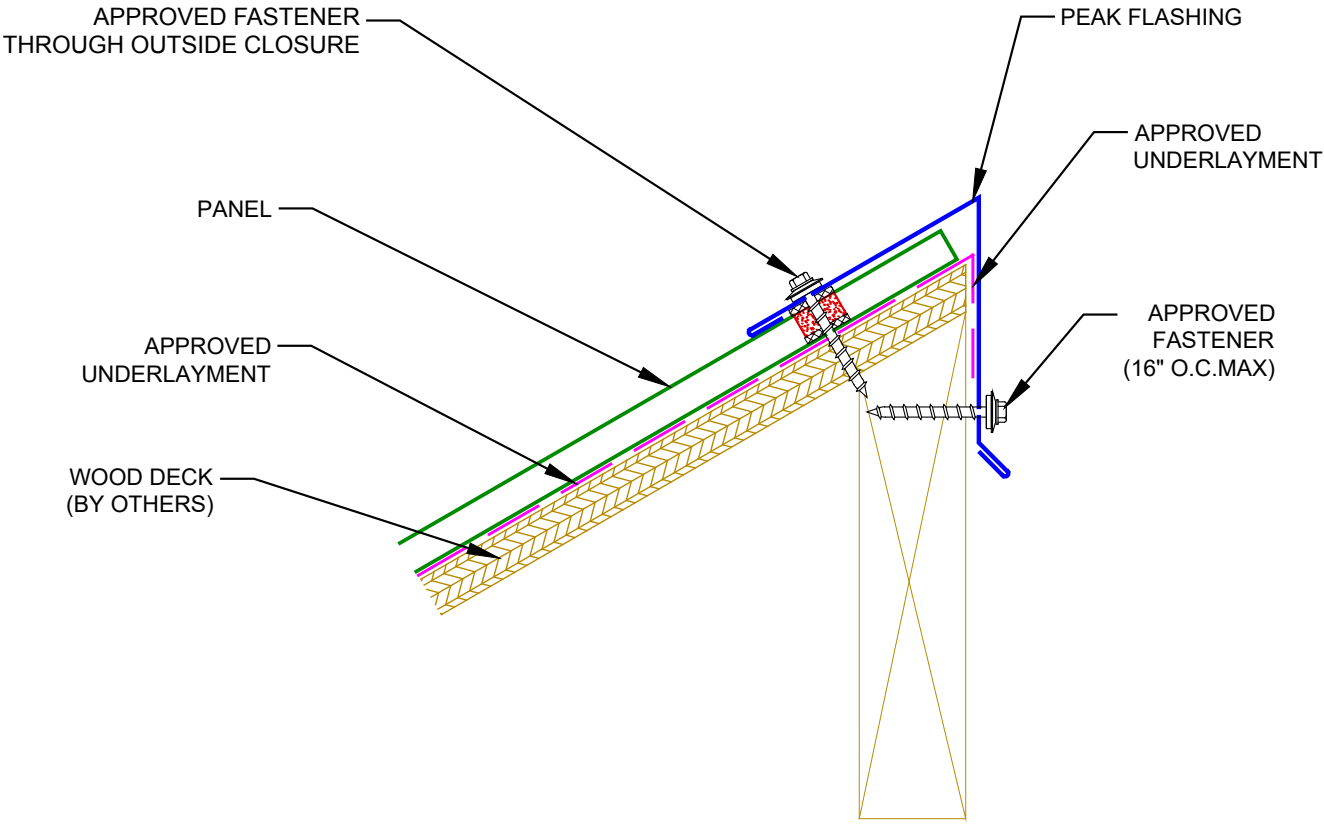

**NOTE:** 4" MIN. LAP ON PEAK CAP TRIM WITH APPROVED SEALANT IN LAPS.

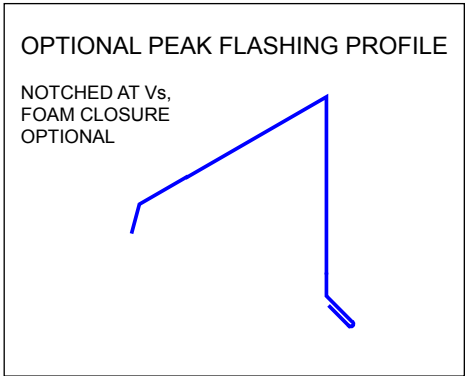

Rev. 12/21

Copyright © 2021 by Metal Alliance Supply LLC. All rights reserved. No part of this document may be reproduced, distributed, or transmitted in any form or by any means, including photocopying, recording, or other electronic or mechanical methods, without the prior written permission of Metal Alliance.

# Headwall-Surface Mount Detail

Detail No. **E-HW1-V** NOT TO SCALE

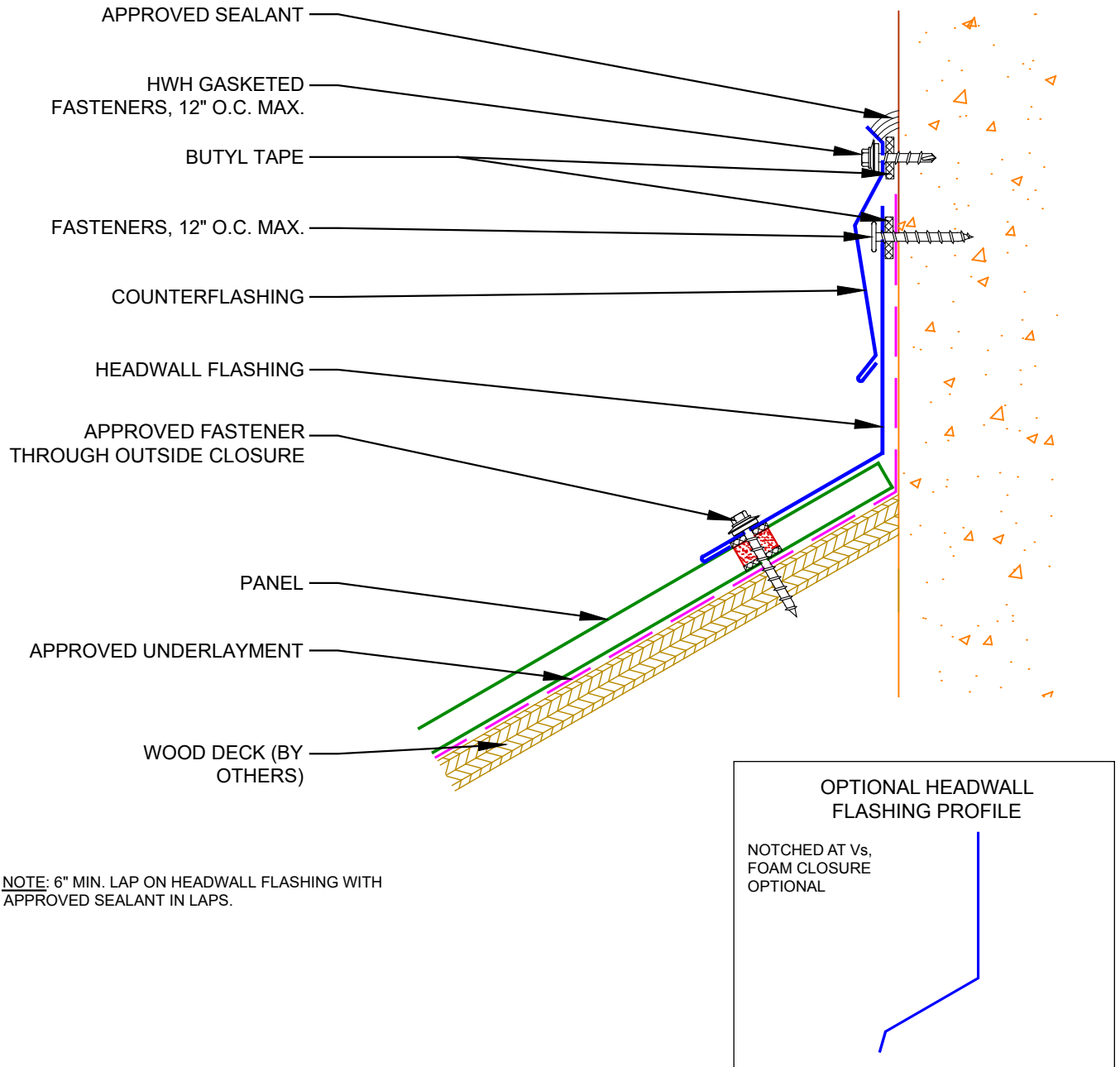

NOTE: 6" MIN. LAP ON HEADWALL FLASHING WITH APPROVED SEALANT IN LAPS.

Rev. 12/21

Copyright © 2021 by Metal Alliance Supply LLC. All rights reserved. No part of this document may be reproduced, distributed, or transmitted in any form or by any means, including photocopying, recording, or other electronic or mechanical methods, without the prior written permission of Metal Alliance.

# Headwall - Reglet Detail

Detail No. **E-HW2-V** NOT TO SCALE

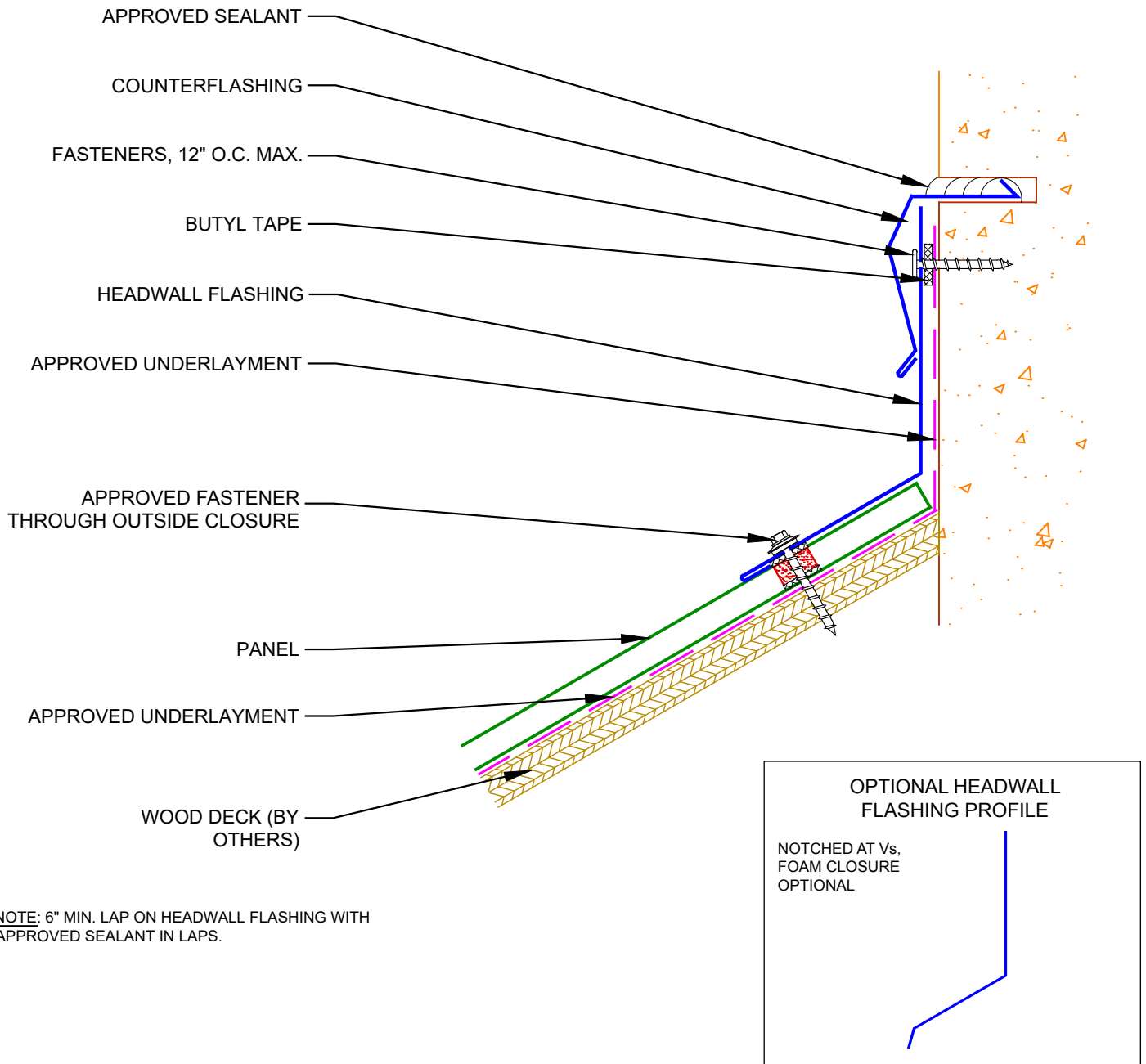

**NOTE:** 6" MIN. LAP ON HEADWALL FLASHING WITH APPROVED SEALANT IN LAPS.

Rev. 12/21

Copyright © 2021 by Metal Alliance Supply LLC. All rights reserved. No part of this document may be reproduced, distributed, or transmitted in any form or by any means, including photocopying, recording, or other electronic or mechanical methods, without the prior written permission of Metal Alliance.

# Headwall - Siding Detail

Detail No. **E-HW3-V** NOT TO SCALE

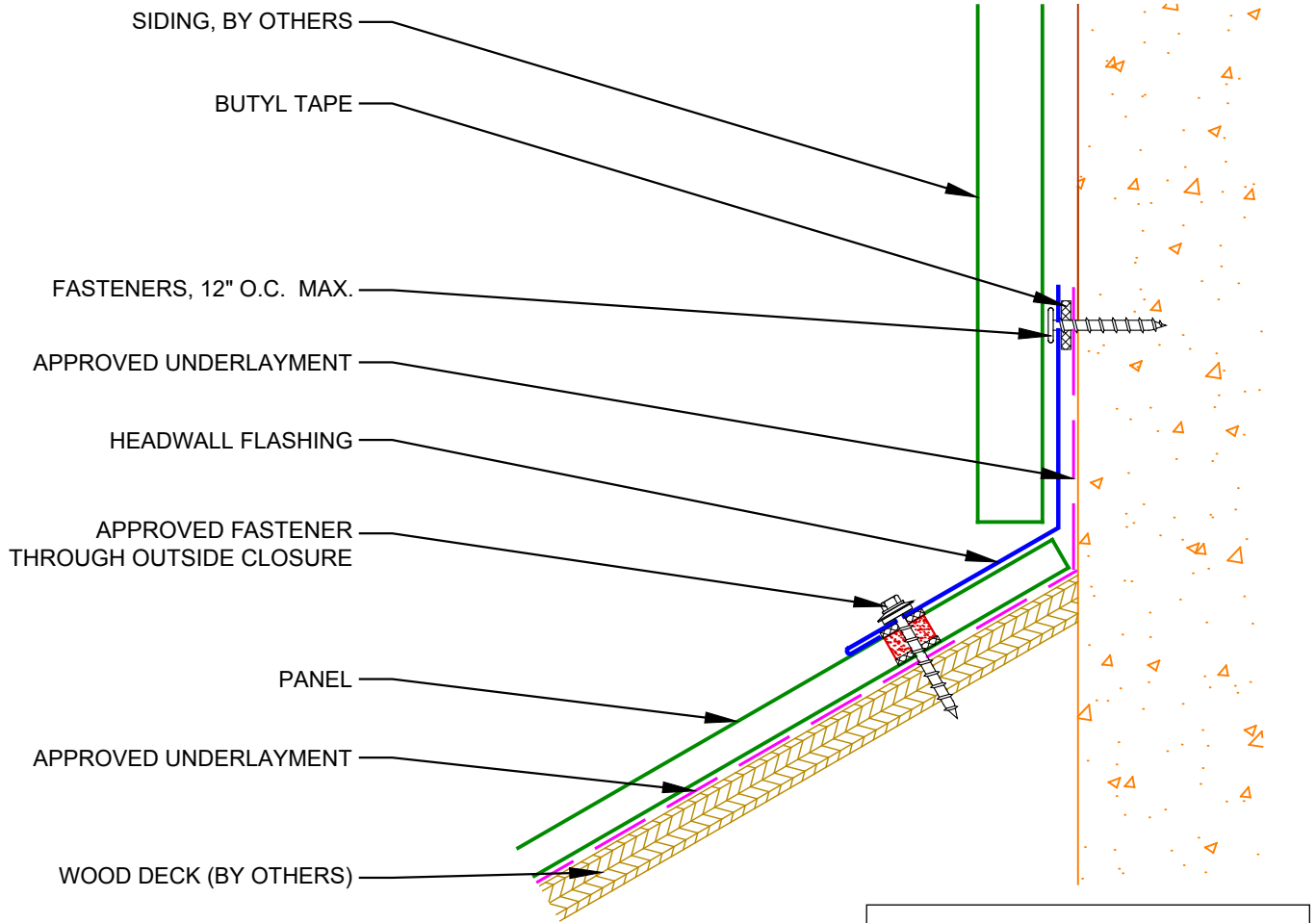

NOTE: 6" MIN. LAP ON HEADWALL FLASHING WITH APPROVED SEALANT IN LAPS.

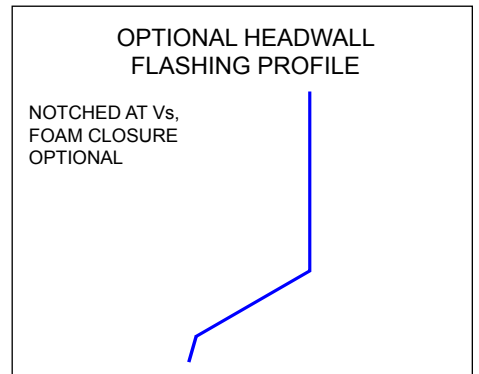

Rev. 12/21

Copyright © 2021 by Metal Alliance Supply LLC. All rights reserved. No part of this document may be reproduced, distributed, or transmitted in any form or by any means, including photocopying, recording, or other electronic or mechanical methods, without the prior written permission of Metal Alliance.

# Valley Wall - Surface Mount Detail

Detail No. **E-VW1-V** NOT TO SCALE

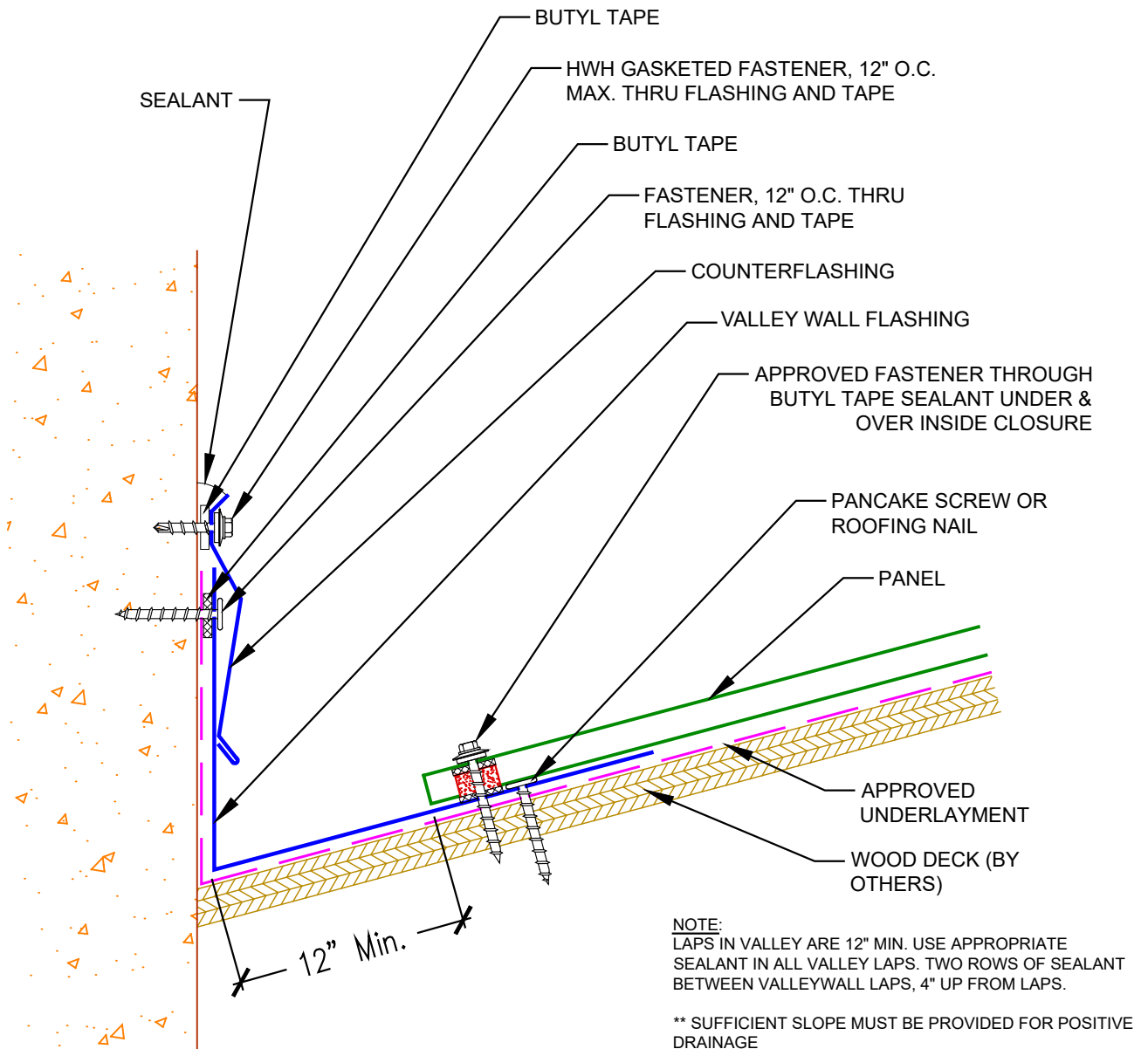

Rev. 12/21

Copyright © 2021 by Metal Alliance Supply LLC. All rights reserved. No part of this document may be reproduced, distributed, or transmitted in any form or by any means, including photocopying, recording, or other electronic or mechanical methods, without the prior written permission of Metal Alliance.

# Valley Wall - Reglet Detail

Detail No. **E-VW2-V** NOT TO SCALE

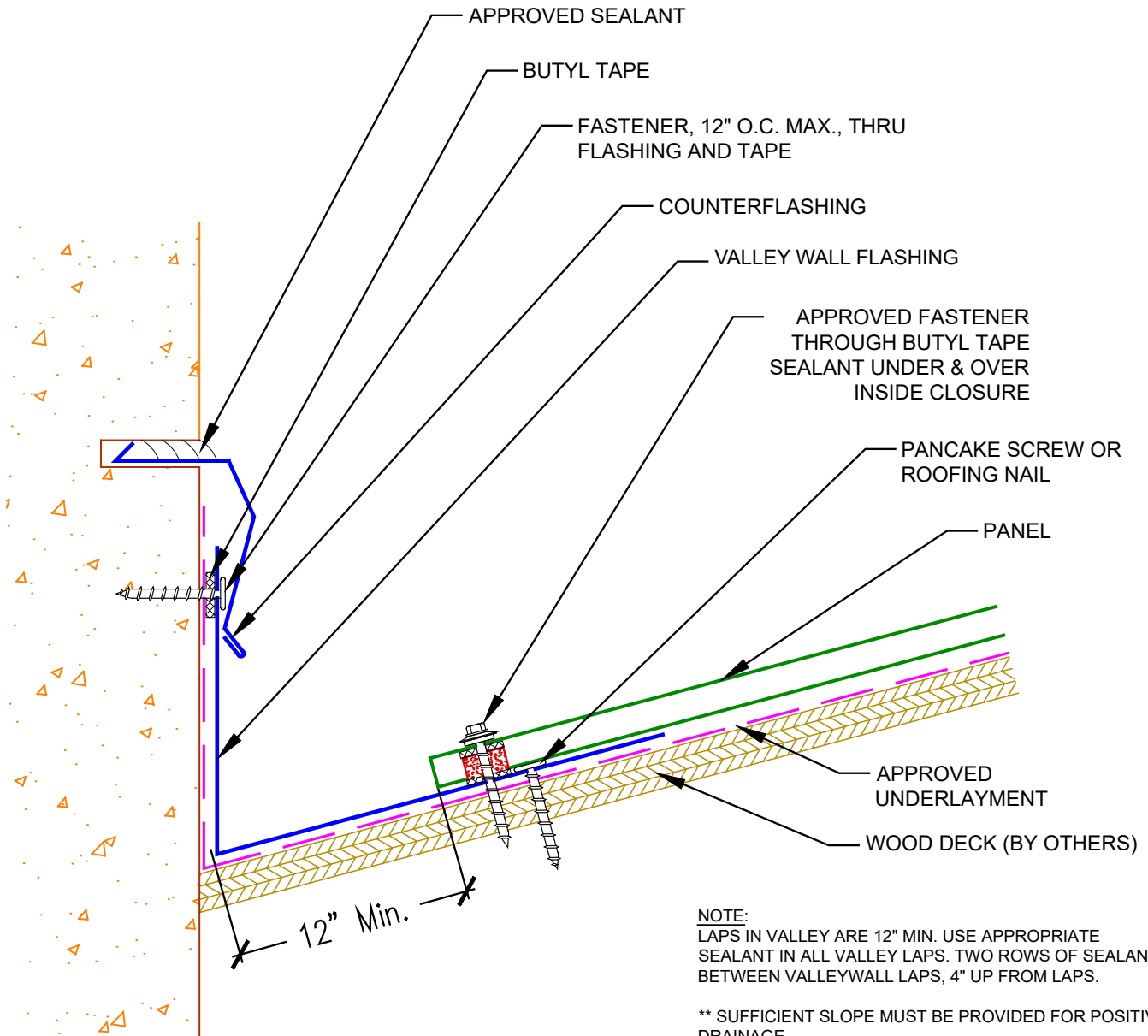

Rev. 12/21

Copyright © 2021 by Metal Alliance Supply LLC. All rights reserved. No part of this document may be reproduced, distributed, or transmitted in any form or by any means, including photocopying, recording, or other electronic or mechanical methods, without the prior written permission of Metal Alliance.

# Valley Wall - Siding Detail

Detail No. **E-VW3-V** NOT TO SCALE

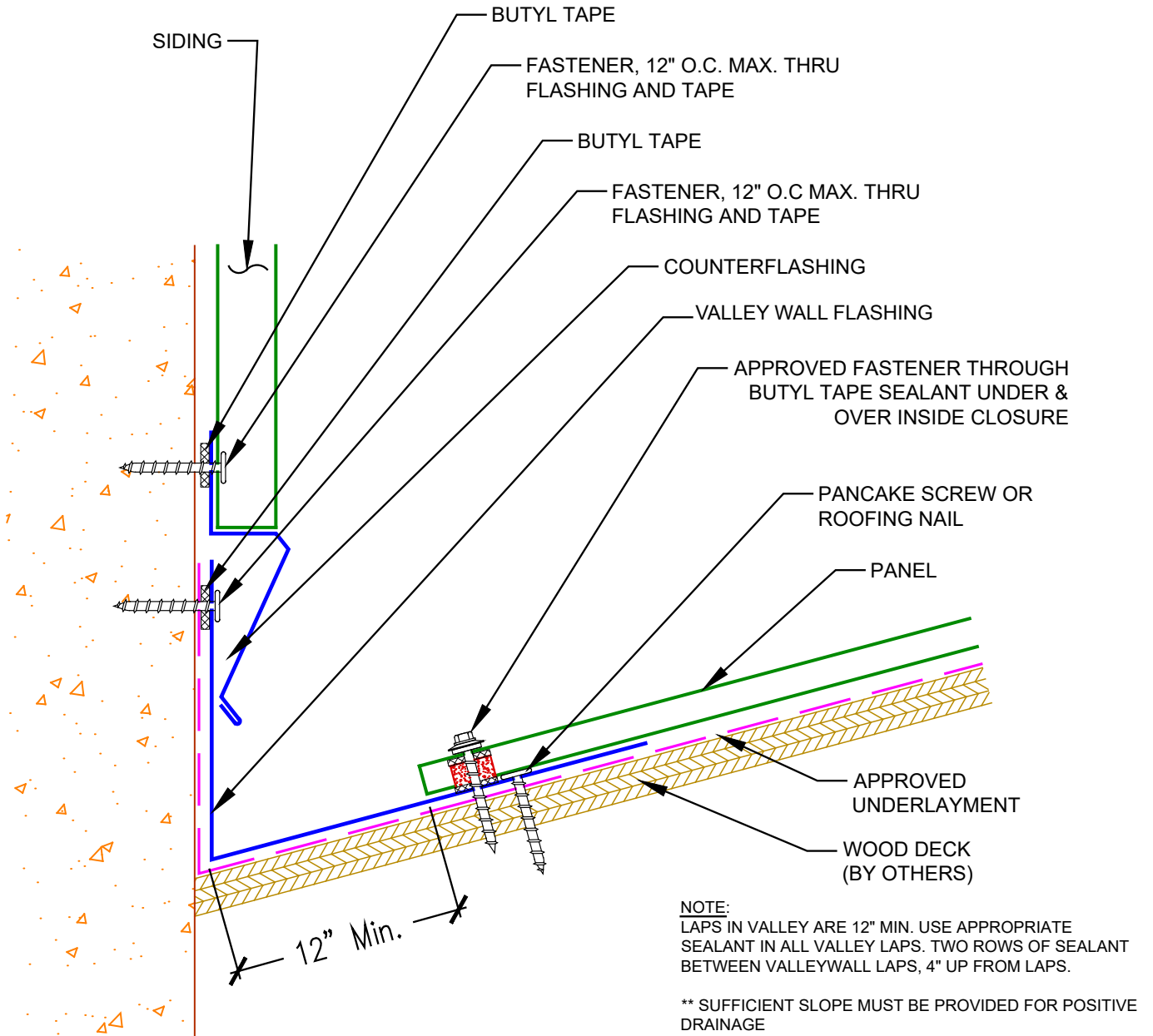

Rev. 12/21

Copyright © 2021 by Metal Alliance Supply LLC. All rights reserved. No part of this document may be reproduced, distributed, or transmitted in any form or by any means, including photocopying, recording, or other electronic or mechanical methods, without the prior written permission of Metal Alliance.





# Sidewall - Reglet Detail

Detail No. **E-SW2-V** NOT TO SCALE

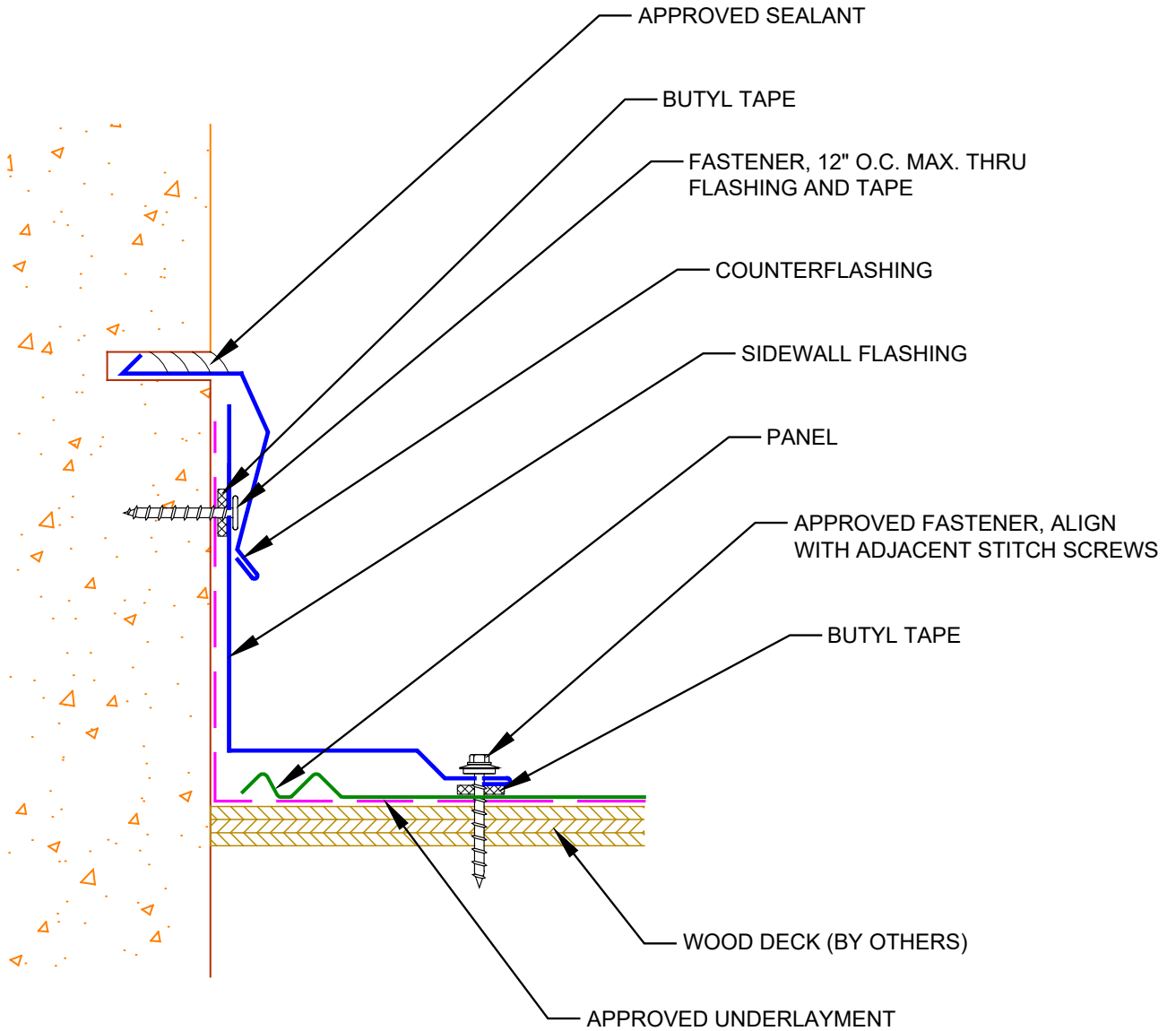

**NOTE:** 6" MIN. LAP ON SIDEWALL FLASHING WITH APPROVED SEALANT IN LAPS.

Rev. 12/21

Copyright © 2021 by Metal Alliance Supply LLC. All rights reserved. No part of this document may be reproduced, distributed, or transmitted in any form or by any means, including photocopying, recording, or other electronic or mechanical methods, without the prior written permission of Metal Alliance.

# Sidewall - Siding Detail

Detail No. **E-SW3-V** NOT TO SCALE

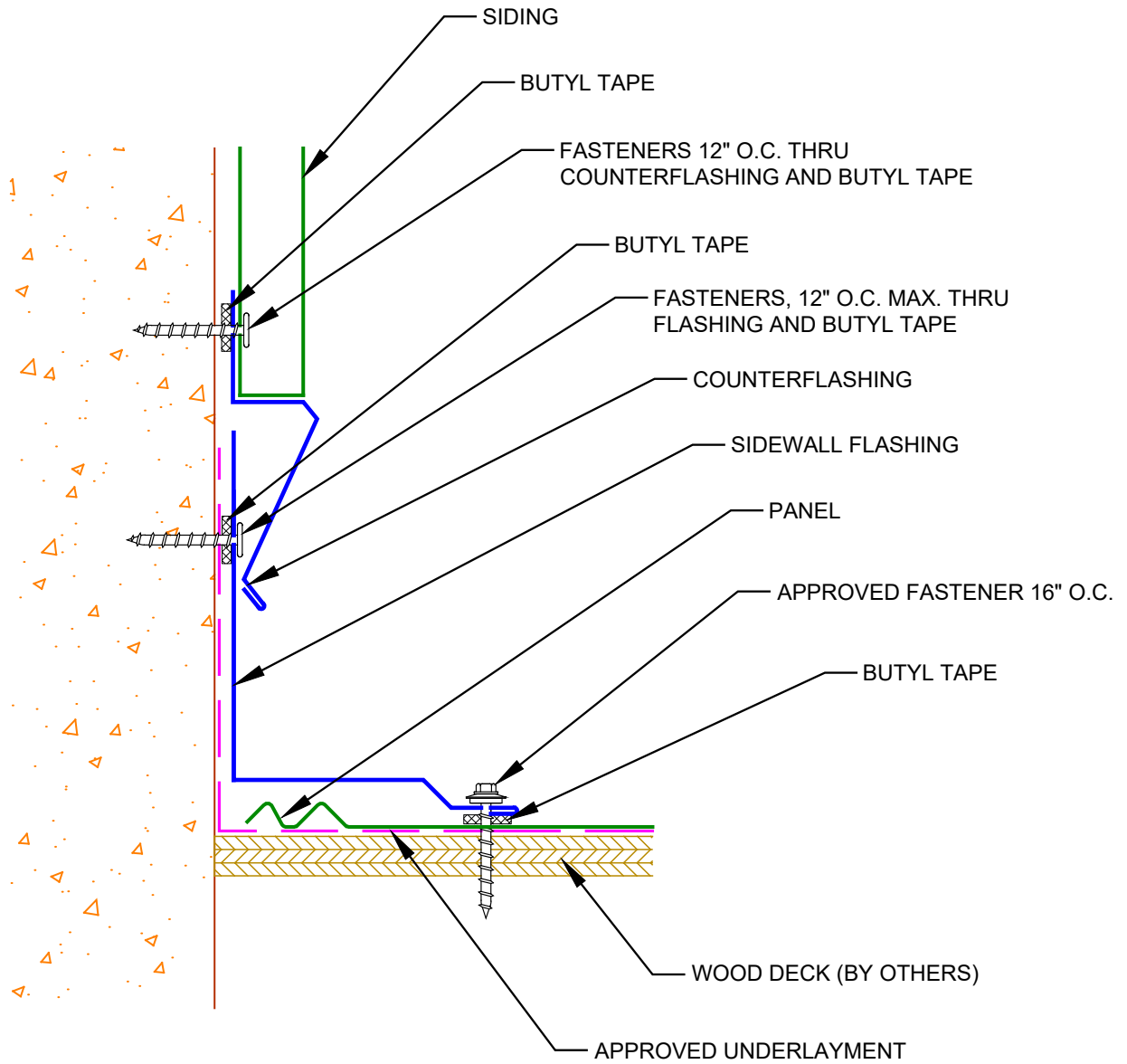

**NOTE:** 6" MIN. LAP ON SIDEWALL FLASHING WITH APPROVED SEALANT IN LAPS.

Rev. 12/21

Copyright © 2021 by Metal Alliance Supply LLC. All rights reserved. No part of this document may be reproduced, distributed, or transmitted in any form or by any means, including photocopying, recording, or other electronic or mechanical methods, without the prior written permission of Metal Alliance.

# Slope Transition Detail

Detail No. **E-ST1-V** NOT TO SCALE

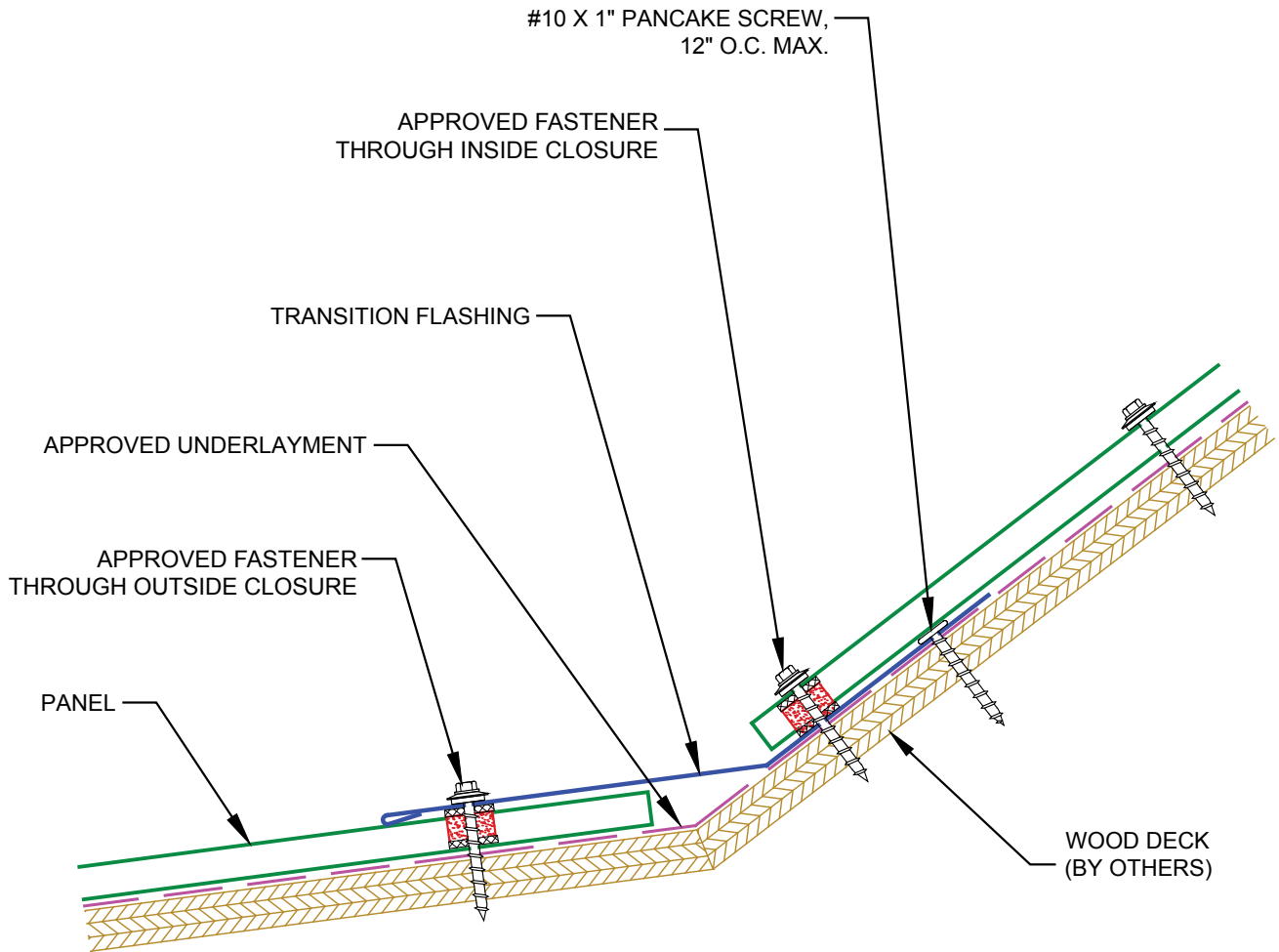

NOTE: 6" MIN. LAP ON TRANSITION FLASHING WITH APPROVED SEALANT IN LAPS.

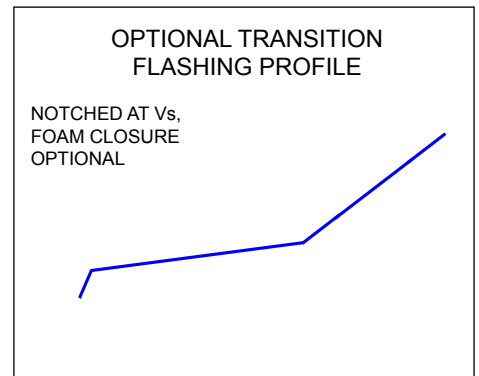

Rev. 12/21

Copyright © 2021 by Metal Alliance Supply LLC. All rights reserved. No part of this document may be reproduced, distributed, or transmitted in any form or by any means, including photocopying, recording, or other electronic or mechanical methods, without the prior written permission of Metal Alliance.

# Penetration Detail

Detail No. **E-PF1-V** NOT TO SCALE

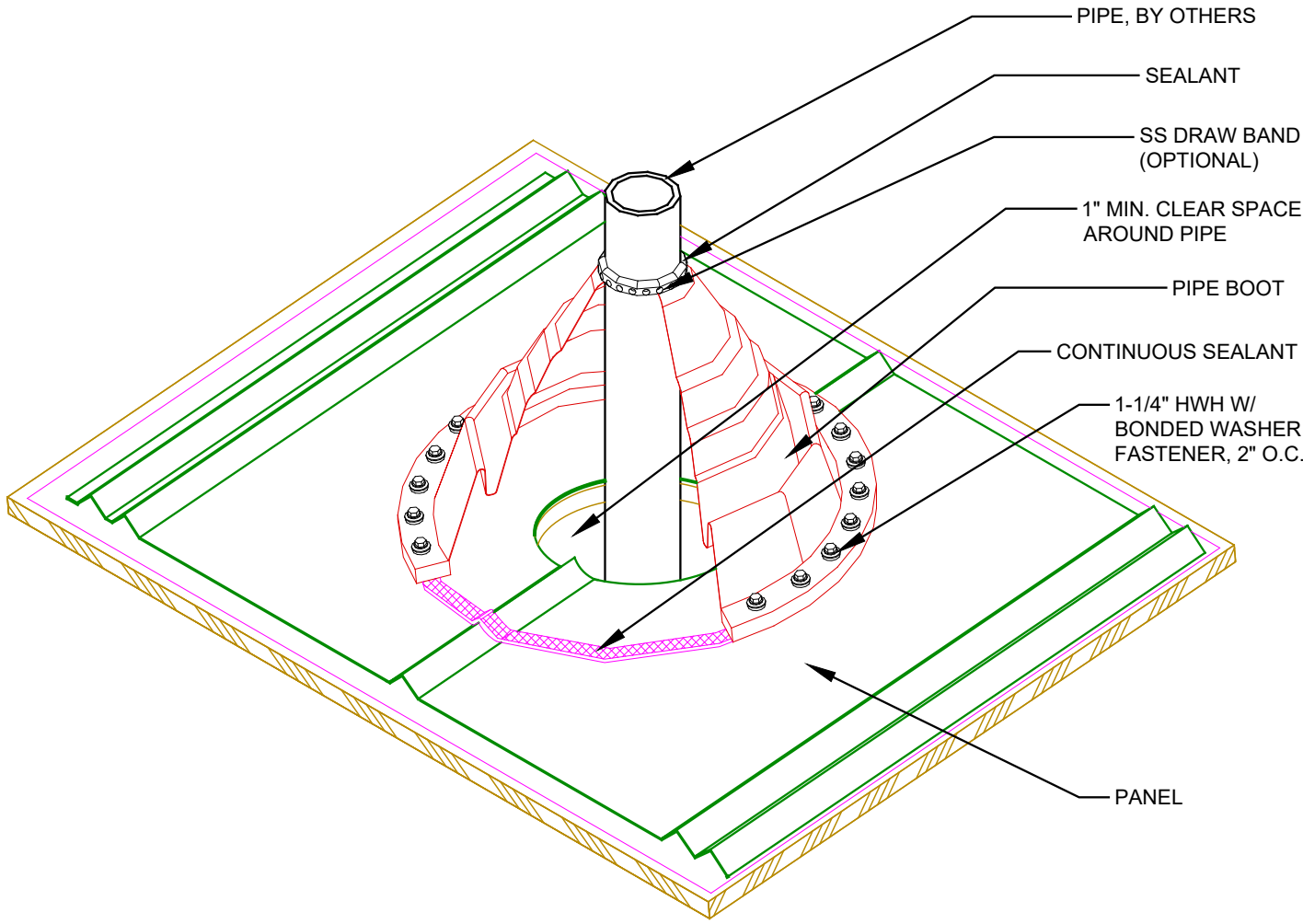

Rev. 12/21

Copyright © 2021 by Metal Alliance Supply LLC. All rights reserved. No part of this document may be reproduced, distributed, or transmitted in any form or by any means, including photocopying, recording, or other electronic or mechanical methods, without the prior written permission of Metal Alliance.

# Endlap Detail

Detail No. **E-EL1-V** NOT TO SCALE

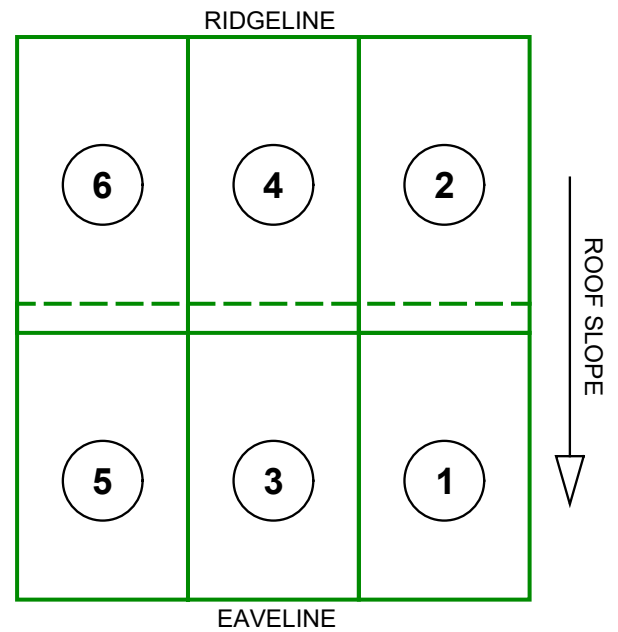
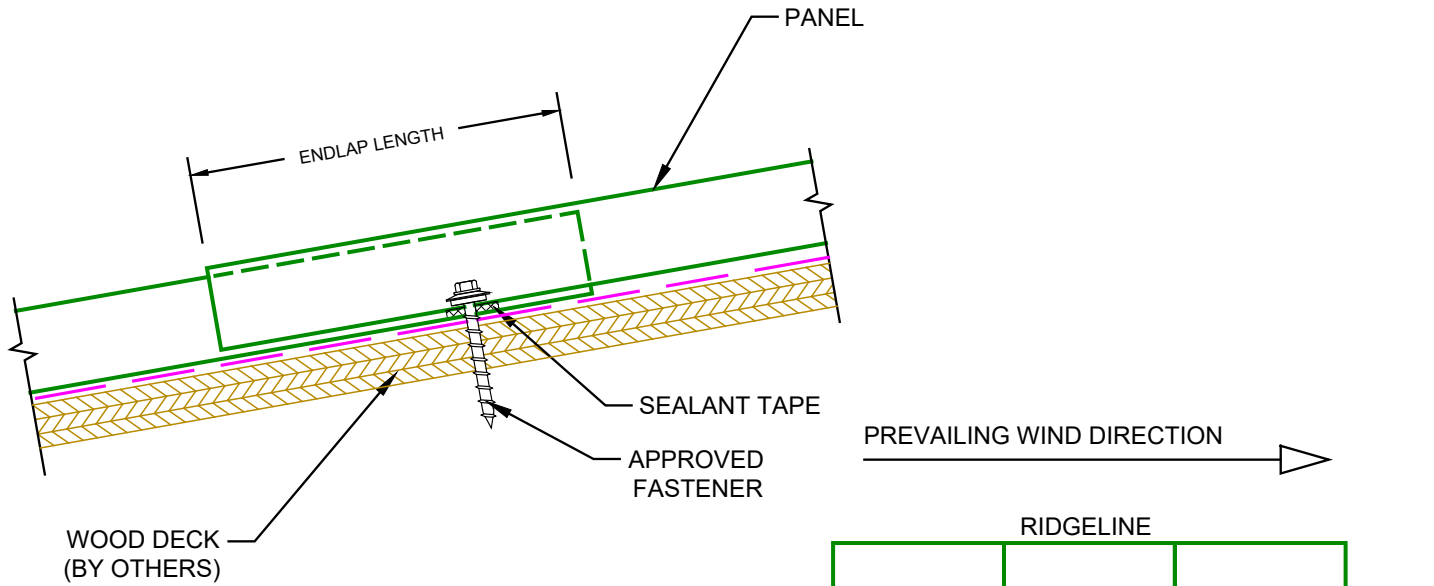

PANEL INSTALLATION SEQUENCE

SLOPE	ENDLAP LENGTH
2:12 & LESS	12"
3:12	9"
4:12 & GREATER	6"

Rev. 12/21

Copyright © 2021 by Metal Alliance Supply LLC. All rights reserved. No part of this document may be reproduced, distributed, or transmitted in any form or by any means, including photocopying, recording, or other electronic or mechanical methods, without the prior written permission of Metal Alliance.



# YOUR METAL TITAN

Inventory ✦ Quality ✦ Service ✦ Value

Have more questions?

[needmetal@metalliance.com](mailto:needmetal@metalliance.com)

[metalliance.com](http://metalliance.com)



2120 SW Poma Dr - Palm City, FL 34990

2500-B Broening Hwy - Baltimore, MD 21224

☎ 844.638.2548 ✉ [needmetal@metalliance.com](mailto:needmetal@metalliance.com)